

AX QuikStart Guide

- INITIAL INSTALLATION INSTRUCTIONS -

Before proceeding with the installation of the AX system, please review these instructions.

1. The complete AX System Installation & Operation Manual is located on the CD included with the CEU.
2. The software program to set up the CEU is located on the CD as well. The CEU must be configured specifically for your system in order for it to function properly.
3. Included with the CEU is a USB to serial converter, along with a gender changer. This is supplied to allow any PC with a USB port to be used to program the AX CEU.

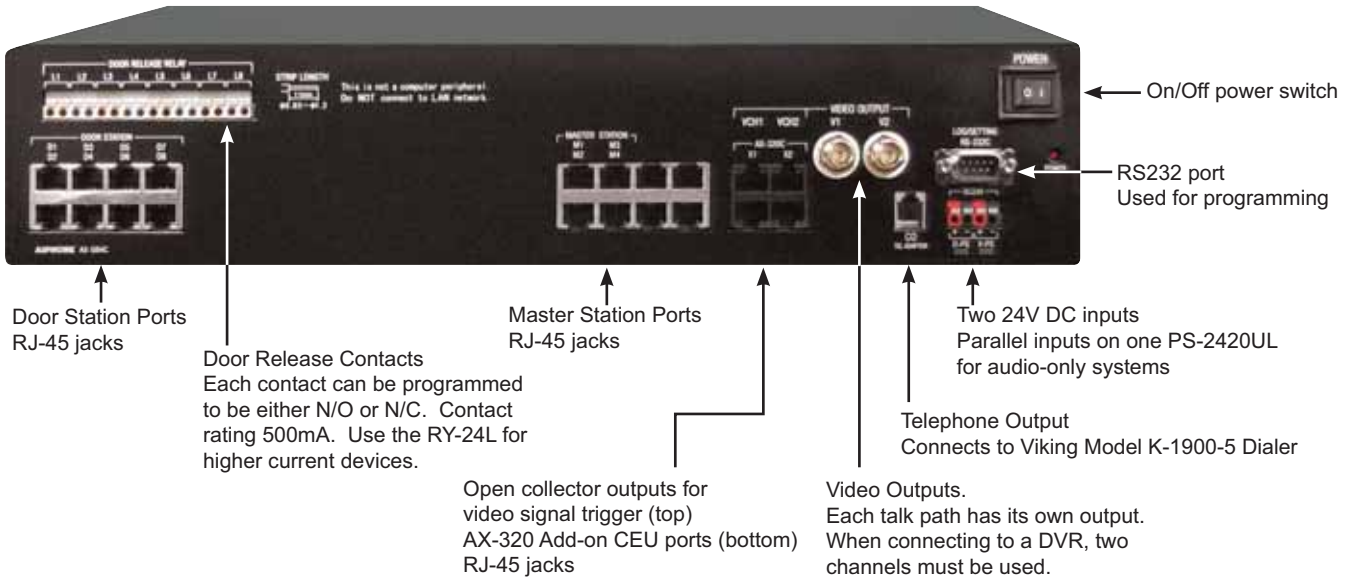

Connecting Central Exchange Unit to Computer via USB-to-Serial Converter:

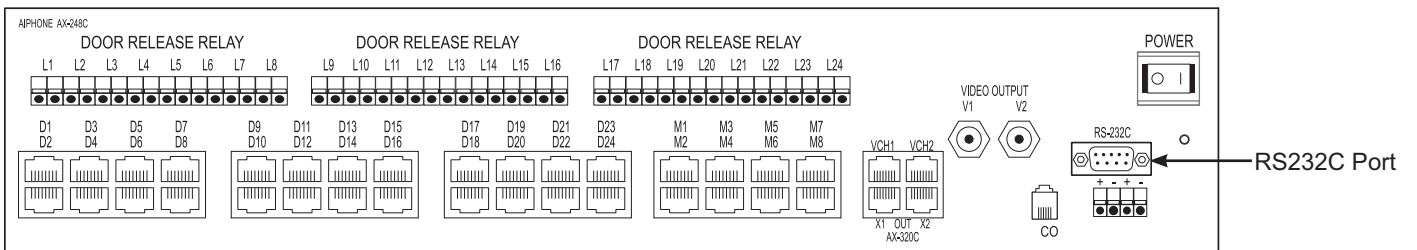

1. Connect power supplies and turn on CEU.
2. If a serial output is not available on your PC, install the USB driver that comes with the converter on your PC.
3. Attach the gender changer to the converter and plug converter into the RS232 port on the AX Exchange unit.
4. Plug the other side of the USB converter into the USB port on the computer.

This will allow you to upload and download program information between the PC and CEU via the AX Setup Tool program.

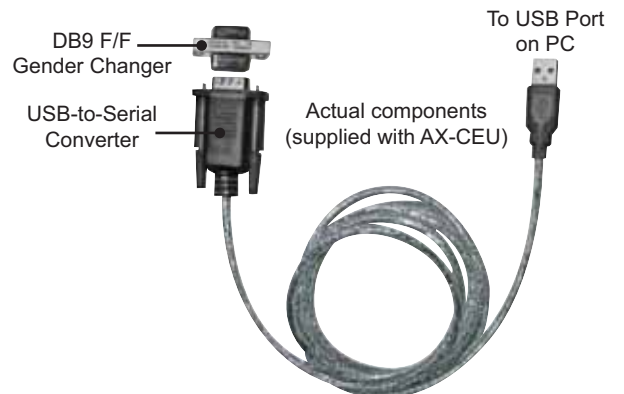

Installing the Software

Insert the CD or download the AX software from our website. Open the AXSetup.exe program and you will be presented with a dialog box asking where to install the AX program. The dialog box will look like one of these depending on the language packs installed on the PC.



Click on the button next to the dialog box [R] or [Reference...], this will bring up a window entitled "Browse for Folder". Select a memorable destination (i.e. Desktop) and then press [OK] to complete the Browse for Folder window, and then [OK] on the "SFX" window to extract the AX software to that destination. To open the software, navigate to that location and then double click the AXSetupEN.exe icon.

Installing the USB-to-Serial driver

If you are utilizing the provided USB-to-Serial cable, download the drivers from our website (<http://www.aiphone.com/products/downloads/>) or insert the mini-CD supplied with the AX-CEU. Open the CD-ROM drive from My Computer named *Driver*. Open the folder *USB TO SERIAL CABLE V1.1*, then open the folder *Windows*. Open the folder *Install*, then open the application *PL-2303 Driver Installer*. Follow the messages to install and restart the computer if prompted.

Plug in the cable to the computer and determine the COM port assigned to it by clicking the *Start* button and right-clicking on *My Computer* and select *Properties* from the drop down menu. When the System Properties window appears, select the *Hardware* tab and click the *Device Manager* button. With the Device Manager open, scroll to *Ports (COM & LPT)*. The Aiphone supplied USB-to-Serial converter will be shown as *Prolific USB-to-Serial Comm Port (COMx)*; the number where the "x" is indicates the COM port number to be chosen in the AX Setup Utility.

Note: The AX Setup Utility will only recognize COM ports numbered from COM1 to COM9. If the default COM port is outside of that range, reassign COM port numbers by right clicking the driver and choosing Properties from the drop down menu. Click Advanced and choose an unused port between 1 and 9.

Configuring the AX Central Exchange Unit:

The following describes the basics of the AX Setup Tool. Note that the CEU MUST be programmed via a PC in order for the system to work. Without programming, only Master1 (M1) and Door 1 (D1) will operate when connected to the CEU.

1) Central Exchange Unit

Step 1: Select the COM Port you will be using. (Based on using existing serial port or USB port with converter.)

Step 2: Select which model CEU that you are using via the dropdown box.

Step 3: If any AX-320C add-on CEU's are included, click "Connected" for each one.

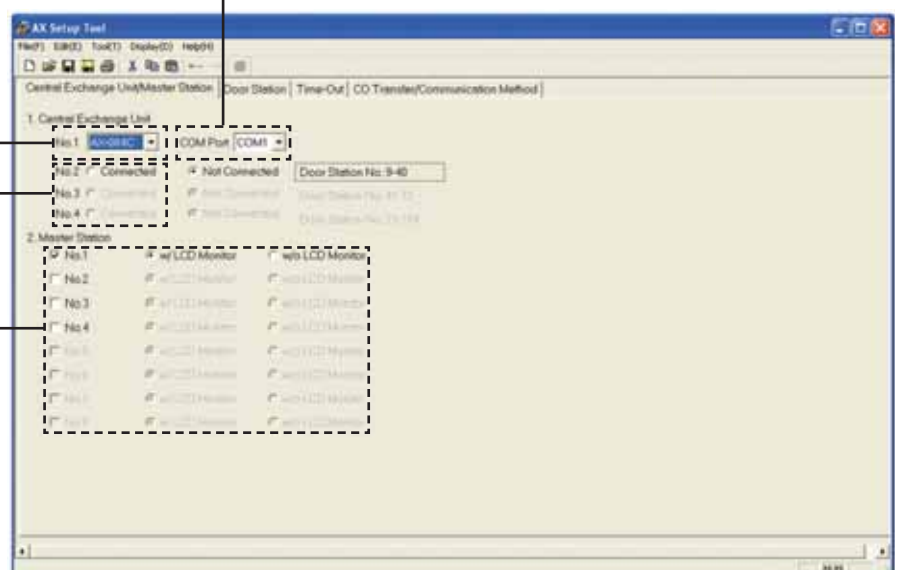

2) Master Station

Step 1: Select the number of masters being used and whether it is a video master or audio only master.

3) Door Station

Step 1: Fill in location name of each door station if desired. (Not required. Names are not stored in the CEU)

Step 2: Select Video, Audio, or None depending on which type of door station is connected to each input. (If setting remains on Video when an audio-only door station is used, the AX-8MV's LCD will display a snowy picture when that station is active.)



Step 3: Set the call priority level by selecting Priority or Normal from the Call Level tab. Priority level calls will have a faster call tone and flashing LED on the master.

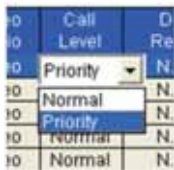

Step 4: Set the door release contact to either Normally Open or Normally Closed by selecting N.O. (Normally Open) or N.C. (Normally Closed) on the DR Relay tab. The default is N.O.



Step 5: Enable or disable each station for being eligible for scanning by selecting Enable or Disable from the Scan Monitor Tab.

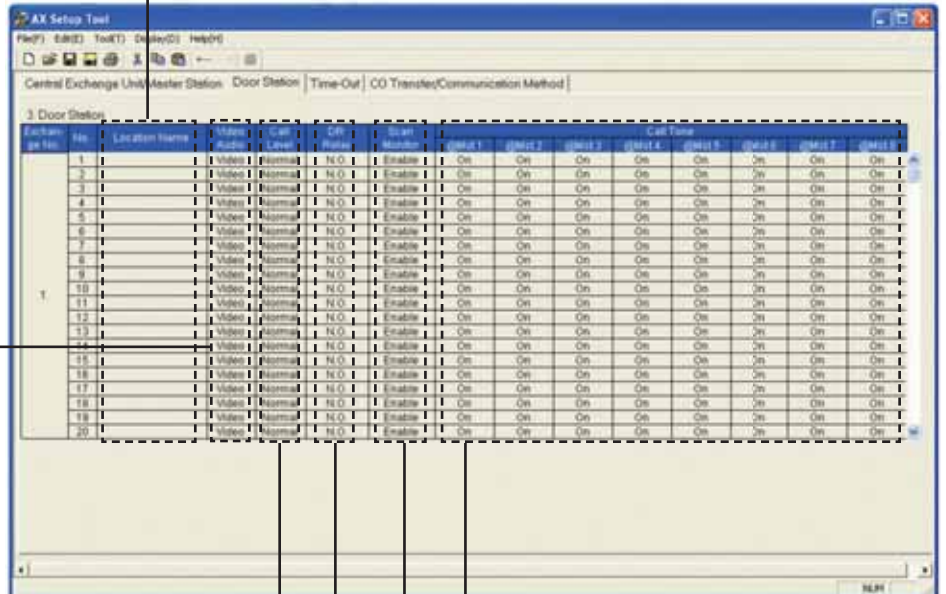
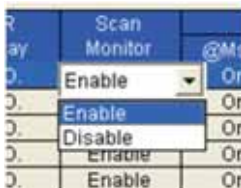

Step 6: Select if you want the door station's call tone to ring on each master station by selecting On or Off from the Call Tone tab. Please note that when set to "Off", the LED and monitor will still come on at the master when the door calls in. Only the call tone will be muted.



4) Time-Out

Step 1: Set Call-in time for door stations from 10 to 600 seconds or to infinite if the call is to ring until it is answered. (Set for both Normal and Priority Calls)

Step 2: Set the duration of an All Call announcement from 10 to 600 seconds. (Set for both Normal and Priority Calls)

Step 3: Set the CO Transfer time from 10 to 300 seconds for how long a CO transferred call will ring the outside telephone line.

Step 4: Set the Communication time for the maximum amount of time allowed for an intercom conversation (30 to 600 seconds). Set the CO Communication time for the maximum amount of time allowed for a CO transferred call (30 to 600 seconds).

Step 5: Set the Door Release Relay setting for the duration of time that the contacts are to be activated.

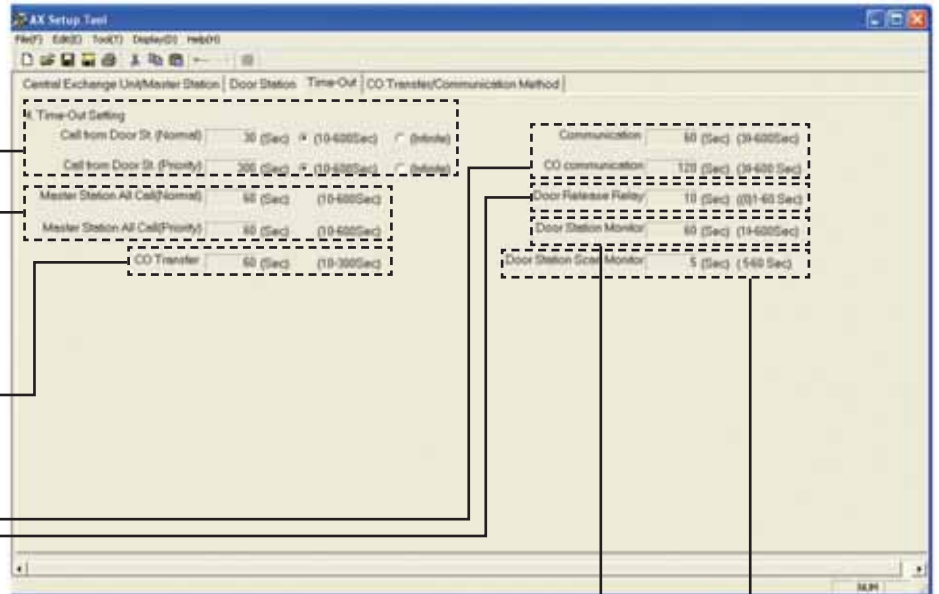

Step 6: Set the Door Station Monitor for the amount of time that you want to be able to listen in to a door station (10 to 600 seconds). When a door station is selected, the master will be in listen mode for this length of time, then will time out..

Step 7: Set the Door Station Scan Monitor for the amount of time that you want to listen to each door station while in Scan Monitor mode (5 to 60 seconds).

5) CO Transfer

Step 1: If using the CO Transfer feature, click on the Enable button. If not, skip to section 6, Communication Method.

Step 2: If Reverse Polarity Detection is required for your phone line, click on Detect. This is sometimes required, depending on the phone line.

Step 3: The wait time for Ring-Back-Tone can be adjusted from 1-60 seconds.

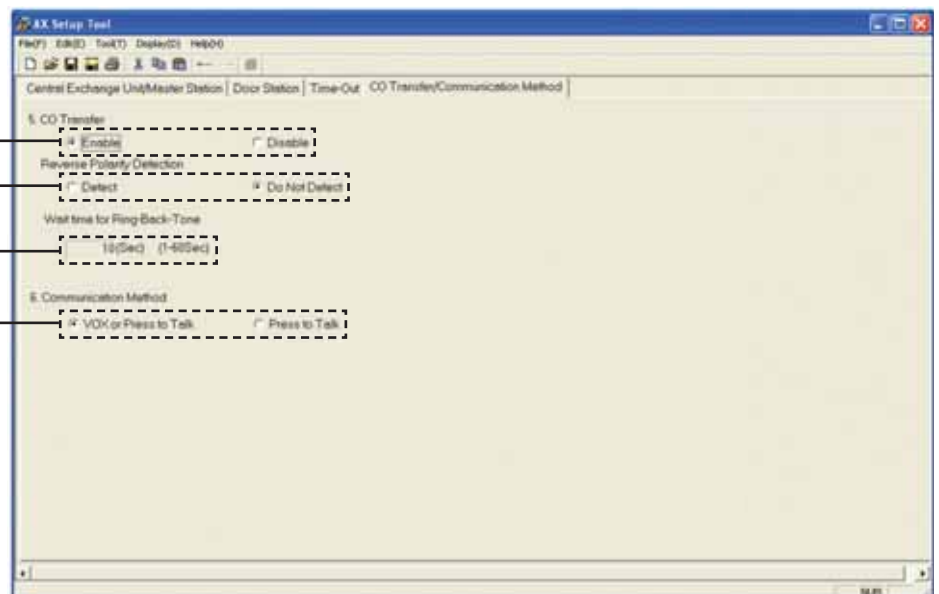

6) Communication Method

Step 1: The Communication Method can be switched from "VOX or Press-to-Talk" to "Press-to-Talk" only. If "Press-to-Talk" is selected, the hands-free VOX feature will be disabled on all master stations.

4) Saving / Uploading

Step 1: Connect your PC / Laptop to the AX-CEU as shown on page 1. Use the supplied USB-to-Serial Converter and Gender Changer if a Serial port is not available.



Step 2: Save the settings that you have made by clicking on File and then Save As. Use the name of the job or something that describes the job as the file name so you can refer back to it later.



Step 3: Click on Tool, then CEU, then Upload to upload the system settings you have made to the AX-CEU.

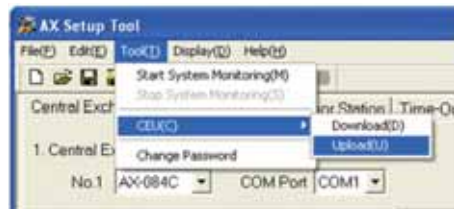

Step 4: Click Yes to the confirmation message asking if you want to overwrite the information in the Central Exchange Unit.



Step 5: Enter the password to authorize the upload. The default password is 9999. Click OK and the new settings will upload to the CEU.



Step 6: When the upload is complete, remove the connector cable from the CEU and save it in a secure location. (This connector will be required when any changes are to be made to the system programming in the future.)

BLOCK DIAGRAM:

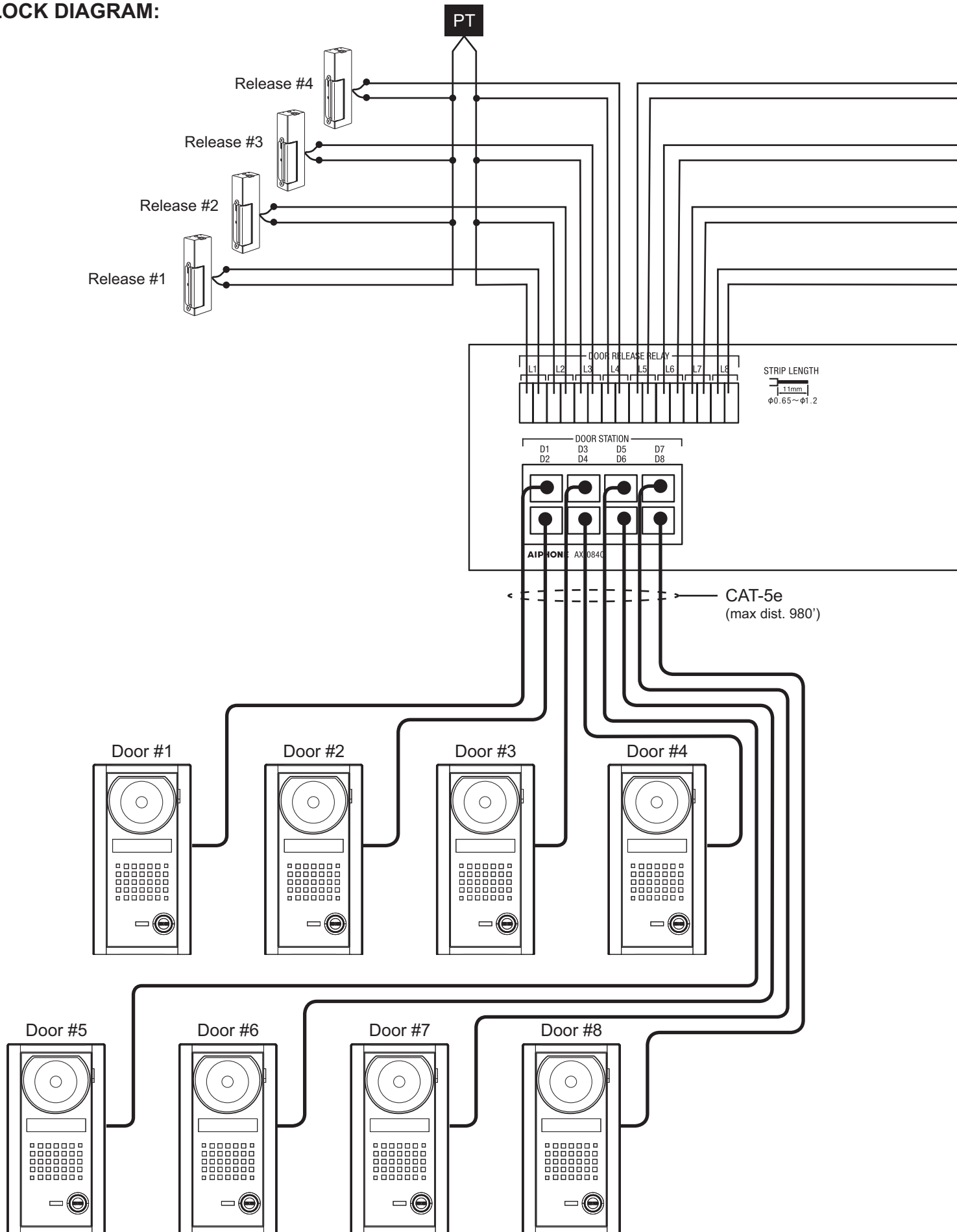

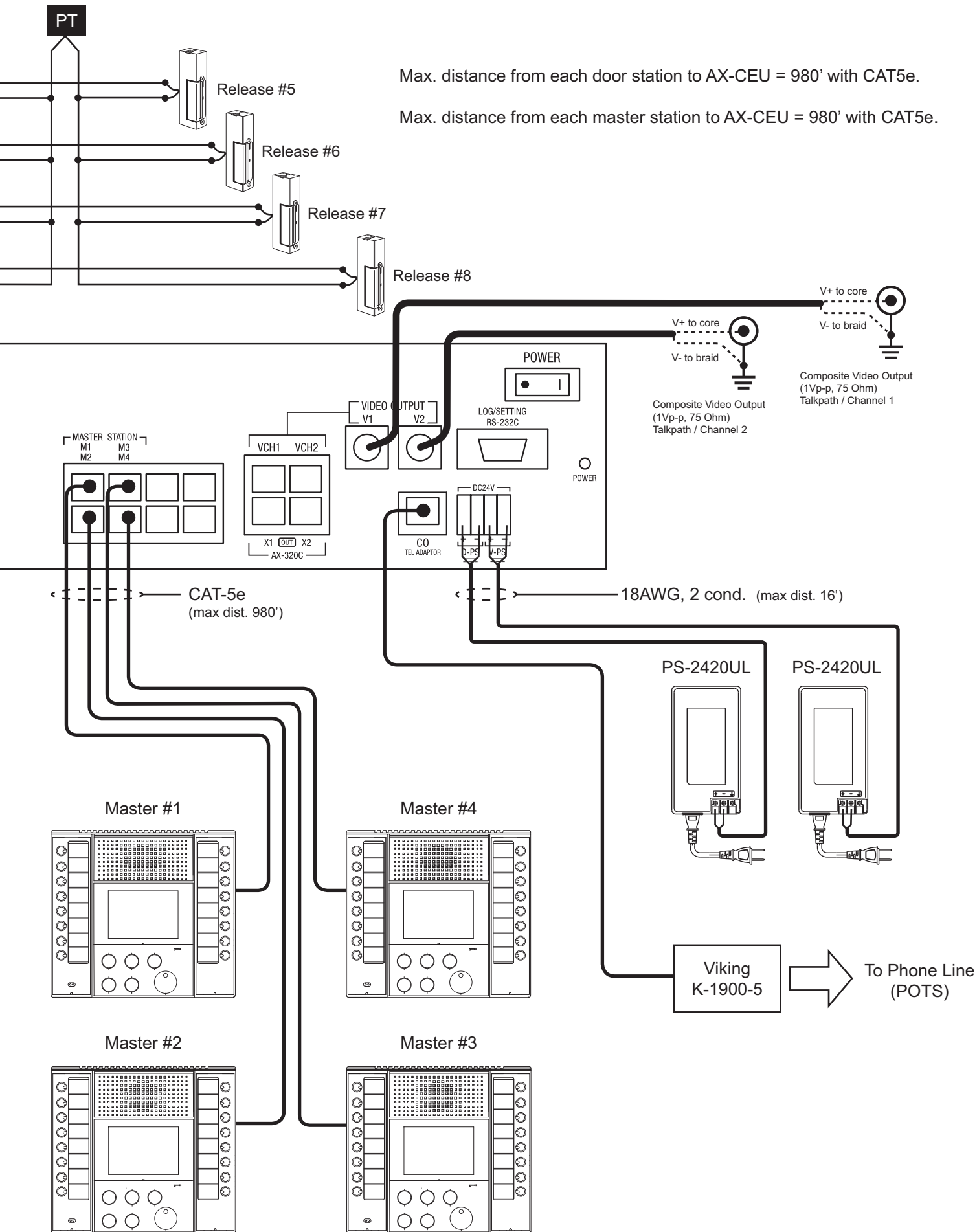

Max. distance from each door station to AX-CEU = 980' with CAT5e.

Max. distance from each master station to AX-CEU = 980' with CAT5e.

AX Master options via included 6-pin connector

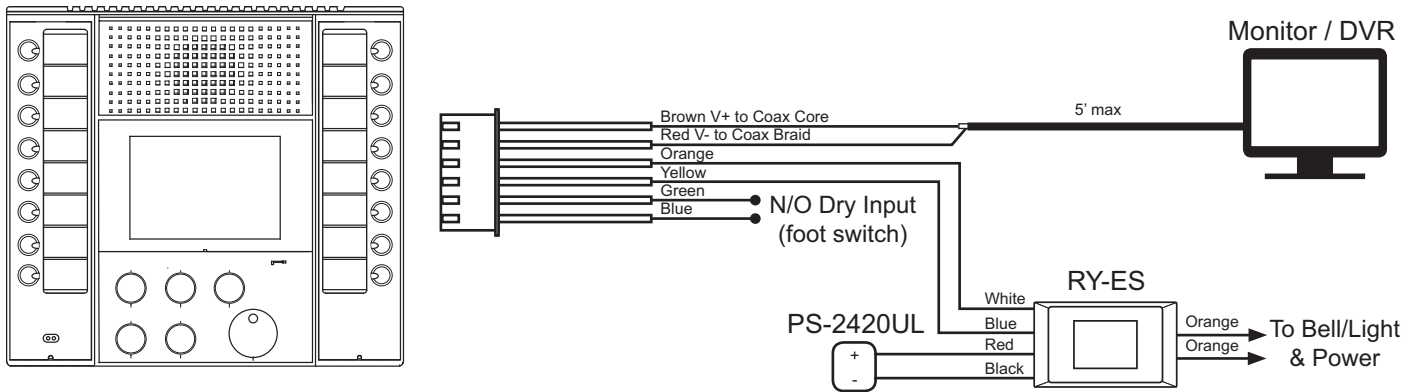

- 1) Connect Brown (V+) and Red (V-) to coax input of standard monitor / DVR. Maximum wire run is 5'. Output is 1Vp-p, 75 ohm.
- 2) Connect Orange and Yellow wires to either an IER-2 chime extension speaker, or to the White and Blue wires on the RY-ES relay for an external device signaling.
- 3) Connect the Green and Blue wires to any normally open dry contact device, to be used in place of the talk button on the master. Contact device should be no more than 50' from the master.

Connecting to Strike/Maglock with RY-24L

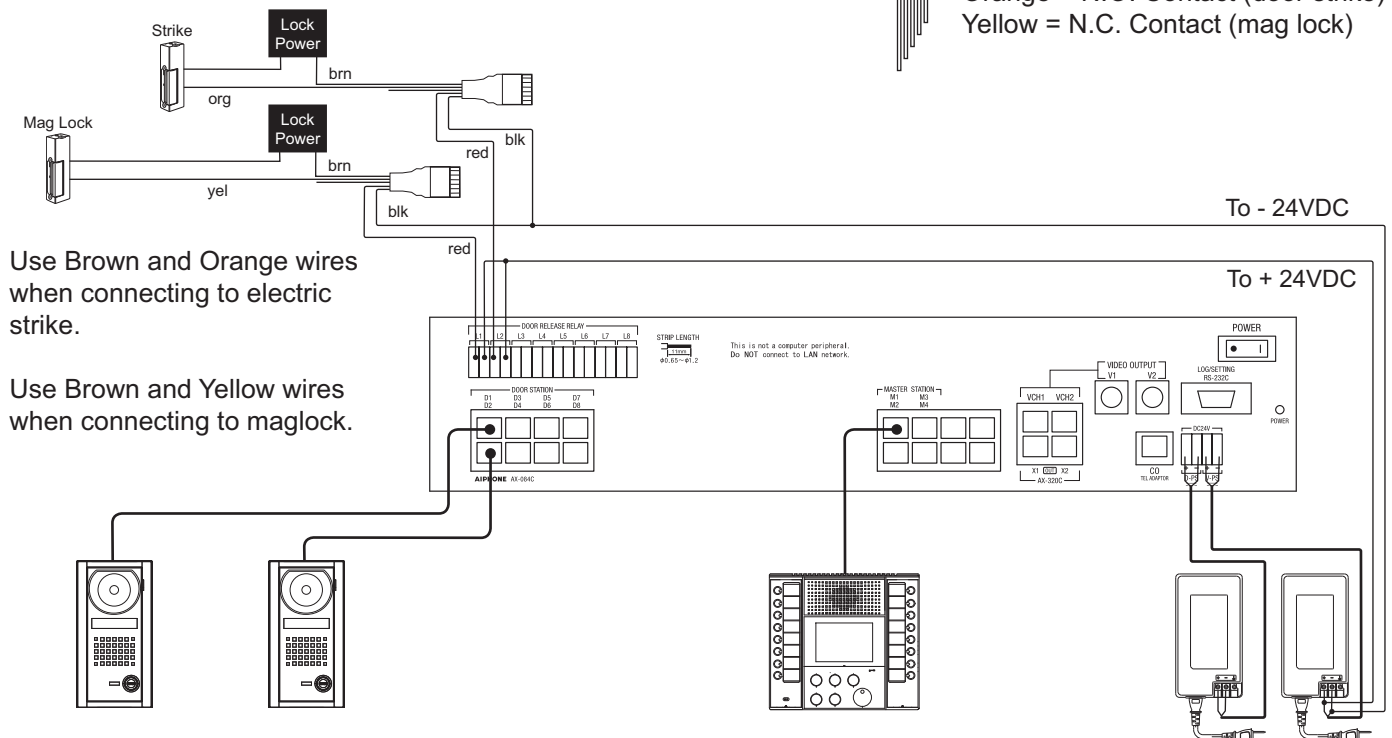
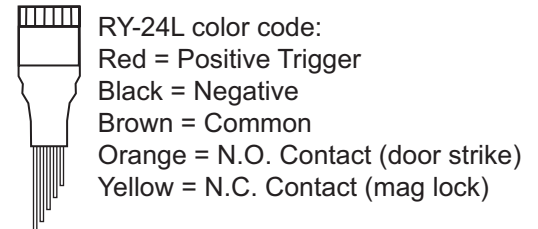

Wiring Terminations:

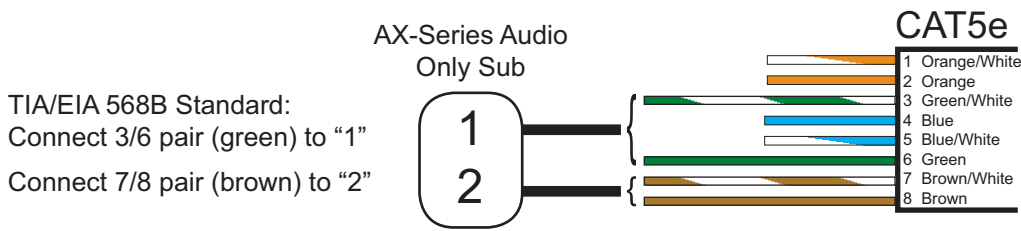

Homerun each sub to
AX-084C, AX-248C, or
AX-320C CEU

AX-Series sub stations include the following:
AX-DM, AX-A, AX-AN, AX-B, AX-BN, IF-DA, IE-DC, IE-JA, IE-SS,
IE-SSR, and IE-SSV.

You can use a standard 2-conductor cable when using an audio-only sub station. At the CEU, splice the 2-conductor cable onto a CAT-5e cable with the splicing method of your choice. Install an RJ-45 plug on the CEU end of the CAT-5e cable, then simply plug it into the AX Exchange Unit.

RJ-45 connectors for the door station ports are located on the left side of the exchange. Please note that the odd numbers are located on top and the even numbers are located on the bottom. The master ports are in the center of the CEU with the odd numbers on top and even numbers on bottom.

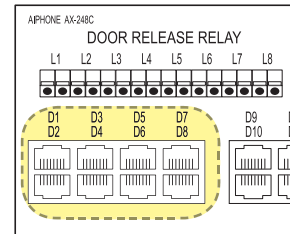

The Door Release Contacts can be individually programmed to be either N/O or N/C. The contacts are located above the door station ports. "L1" are the contacts* for door station port "D1", "L2" are the contacts for "D2", etc. As the "L#" connections are dry contacts, a separate power source is required for the actual door strikes or magnetic locks.

***Note: Dry contact rating: 24V AC/DC, 500mA.**

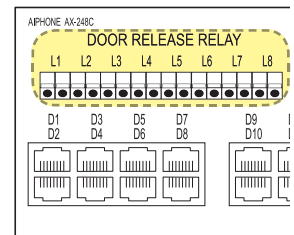

The AX-084C and AX-248C units have a built-in composite video output, one per talk path. When tying to a recording device, such as a DVR, connect each output to separate inputs on the DVR. Each output also has a corresponding trigger, via a normally open collector labeled VCH1 and VCH2. Pin 4 is the trigger and pin 5 is the ground. Please note that the video signal is only present when a video door station is active and there is an image on the AX-8MV's monitor.

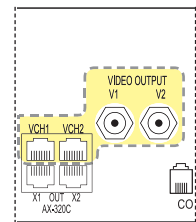

The AX-084C and AX-248C both have the ability to connect to the AX-320C add-on unit. Connect the X1 and X2 with two CAT-5e cables. Both X1 and X2 must be connected and the AX-320C must be within 16 feet of the main CEU.

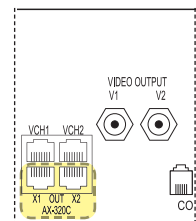

The AX-084C and AX-248C are powered by two PS-2420UL power supplies. One power supply can be used for an audio-only system. When using one power supply, jumper the two + terminals together and connect to + of the power supply. Jumper the two negative's together and connect to - of the power supply. Power for the AX-320C add-on CEU's comes from the system power supplies. Parallel connect power wires to all AX-320's in the system.

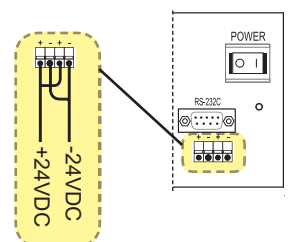

AX Series CAT5e wire Installation Do's and Don'ts

Do	Run all cables in a "Star" configuration. That is to say that they all emanate from and are "homerun" to, one central location, where the AX-CEU will be installed. Visualize a wagon wheel. All of the spokes start from one central point.
Do	Keep all cable runs to a maximum of 980 feet (for each run). IMPORTANT! This is an AX Series specific distance.
Do	Maintain the twists of the pairs all the way to the point of termination, or no more than 1/2" untwisted.
Do Not	Skin off more than 1" of jacket when terminating.
Do	Make gradual bends of the cable where necessary. No sharper than a 1" radius.
Do Not	Allow the cable to be sharply bent or kinked at any time. This can cause permanent damage to the cables' interior.
Do	Dress the cables neatly with cable ties. Use low to moderate pressure.
Do Not	Over tighten cable ties. Hook or Loop (Velcro) Cable Ties work very well for commercial installations.
Do	Cross-connect cables (where necessary) using CAT5e rated punch blocks and components.
Do Not	Splice or bridge CAT5e cable at any point. There should never be multiple appearances of CAT5e cable.
Do	Use low to moderate force when pulling cable.
Do Not	Use excessive force when pulling cable.
Do	Use cable pulling lubricant for cable runs that may otherwise require great force to install.
Do Not	Use oil or any other lubricant not specifically designed for cable pulling. Oil or other lubricants, can infiltrate the cable, causing damage to the installation.
Do	Keep CAT5e cables as far away from potential sources of EMI (electrical cables, transformers, light fixtures, etc.) as possible.
Do Not	Tie cables to electrical conduits or lay cables on electrical fixtures.
Do	Install proper cable supports, spaced no more than 5 feet apart.
Do Not	Install cable that is supported by the ceiling tiles (this is unsafe and may be a violation of building codes).
Do	Always label every termination point. Use a unique number for each cable segment.
Do	Always test every installed segment with a cable tester. "Toning" alone is not an acceptable test.
Do	Always install jacks in such a way as to prevent dust and other contaminants from settling on the contacts. The contacts (pins) of the jack should face up on flush mount plates or left, right. or down (never up) on surface mount boxes.
Do	Always leave extra slack on the cables, neatly coiled up in the ceiling or nearest concealed place. it is recommended that you leave at least 5 feet at the door station side and 10 feet at the CEU side.
Do Not	Install cables "taught" in the ceiling or elsewhere. A good installation should have the cables loose but never sagging.
Do	Always use grommets to protect the cable where passing through metal studs or anything that can possibly cause damage to them.
Do	Configure the RJ45 jacks in the 568B wiring standard. 568B standard is required for the AX system.
Do Not	Use the 568A wiring standard for the AX system.
Do Not (1 Exception)	Use staples on CAT5e cable that crimp the cable tightly. The common T-18 and T-25 cable staples are not recommended for CAT5e cable. The T-59 insulated staple gun is ideal for fastening CAT5e cabling as it does not put any excess pressure on the cable.
Do	Always obey all local and national fire and building codes. Be sure to "firestop" all cables that penetrate a firewall. Use plenum rated cable where it is mandated.

Basic Troubleshooting:

- AX-CEU Power LED flashing:
Possible incorrect program setting for the Central Exchange Unit. If there is no add-on exchange (AX-320C), make sure the program setting for No. 2 through No. 4 is set to "Not Connected". If these are set to "Connected" but no add-on is connected to the main CEU, the power LED will flash.

1. Central Exchange Unit			
No.1	AX-084C	COM Port	COM1
No.2	<input checked="" type="radio"/> Connected	<input type="radio"/> Not Connected	Door Station No. 9-40
No.3	<input checked="" type="radio"/> Connected	<input type="radio"/> Not Connected	Door Station No. 41-72
No.4	<input type="radio"/> Connected	<input checked="" type="radio"/> Not Connected	Door Station No. 73-104

- Audio-only system, door station squeals when station is selected:
Possible power supply connection issue. In an audio-only system with one PS-2420UL, the power terminals must be commoned together on the AX-CEU. Refer to the bottom of Page 9.
- Error message while downloading program to CEU "Error occurred while downloading the setting file":
 1. Power not applied to CEU: Make sure that there is power applied to both the V+ V- and D+ D- on the exchange and that the power LED is on bright when the power switch is in the ON position.
 2. System is currently in use: If there is any current activity on the exchange, such as a master monitoring a door, then the system will not accept programming information. To ensure no activity, unplug the RJ-45 connections from the CEU and only leave power and the programming cable connected.
 3. Check the serial cable being used. If using the provided USB-to-Serial converter cable, make sure that the drivers were installed on your PC (see page 2).
- One of the master station LED's is blinking on the AX master:
When a master station is programmed to be in the system and that station gets unplugged or disconnected in some way, the corresponding master LED will blink quickly on the other master station(s) that are still connected indicating that there is a problem. Check the wiring to the master station assigned to the channel with the blinking LED and reconnect appropriately.
- Video master station still displays video even when a substation is not programmed to call it:
This is not a malfunction. Assigning a substation to only call certain masters simply eliminates it from annunciating (no call tone) at that particular master. Other functions, such as the LED blinking, the monitor coming on, or the master being able to call that substation are still functional.
- AX master not able to hear the door station (stuck in Transmit mode):
Check to see if the 6-pin connector is plugged into the back of the AX master unit. If the blue and green wires are shorted together, separate them. The blue and green wires are for connection of a footswitch to activate the TALK function and if shorted together, the master will be stuck in transmit mode.
- If you are having communication issues, it is recommended to bench test the AX-CEU with the masters and doors using patch cables to insure that the product is functioning normally.

Labeling the Master Station's Directory Cards

Aiphone provides a template for creating professionally printed directory cards for the AX series master stations.

The template is located on the CD included with the CEU.

View the CD contents using My Computer or Windows Explorer.

- Open the file folder called "Directory Card"
- Open PDF document "AX-8MV_DirectoryLetter"
- Type in the location names of master stations and door stations.
- Print and cut the strips to fit in the directory slots on the master stations.
- Remove the plastic directory cover and replace the blank paper strips that are included with the master with the new labeled strips you've just made.
- Replace plastic directory cover.

Example: Directory cards when using template

Master Stations

Door Stations

FRONT OFFICE
S&H OFFICE
EMPL. LOUNGE
SECURITY DESK

FRONT DOOR
EMPL. ENTRANCE
DELIVERY DOOR
ELEVATOR LOBBY

SPECIFICATIONS:

AX-084C, AX-248C

Power Source:	24V DC, 2A (x2), PS-2420UL (1 for audio-only system, 2 for audio/video system)
Current Consumption:	Video (Max) 1.1A, Audio (Max) 1.25A
Door Release Contact:	24V AC/DC, 500mA
Mounting:	Desk, wall, or 19" EIA rack with supplied brackets
Wiring:	RJ45 plugs for CAT5e from masters and doors. 2 Conductor wire from PS-2420UL to power input terminals RJ11 for Viking K-1900-5 programmable auto-dialer
Operating Temperature:	32 - 104° F (0 ~ 40° C)

AX-8MV, AX-8M

Power Source:	24V DC Supplied from CEU
Call Tone:	Tremolo ring tone & blinking LED
Communication:	Open voice hands-free (VOX or Push-to-Talk)
Video Monitor (AX-8MV):	3-1/2" direct view TFT color LCD
Scanning Lines (AX-8MV):	525 lines
Video Output (AX-8MV):	NTSC Standard 1Vpp (0.7 - 1.4Vpp)
Headset Jack:	3.5mm mic and speaker jacks
Mounting:	Desk with flip-up stands, or wall mount with provided metal bracket
Wiring:	RJ45 Plug, CAT5e homerun to CEU
Operating Temperature:	32 - 104° F (0 ~ 40° C)

AX-DV, AX-DVF

Power Source:	24V DC Supplied from CEU
Communication:	Hands-free
Camera:	1/4" Color CCD camera
Pixels:	250,000 Pixels
Minimum Illumination:	5 Lux
Mounting:	AX-DV: Surface wall mount AX-DVF: Flush mount (with provided box)
Wiring:	RJ45 Plug, CAT5e homerun to CEU
Operating Temperature:	14 - 140° F (-10 ~ 60° C)

Aiphone Communication Systems
1700 130th AVE N.E.
Bellevue, WA 98005
(425) 455-0510
FAX (425) 455-0071

Toll Free Technical Support:
1-800-692-0200
E-mail tech@aiphone.com

AX Quikstart Guide
Pg. 12
Stock # 96501
1010JDPH