

# AIPHONE

## JKW-IP

### IP Video Intercom Adaptor

## OPERATION MANUAL

### JKW-IP

IP Video Intercom Adaptor

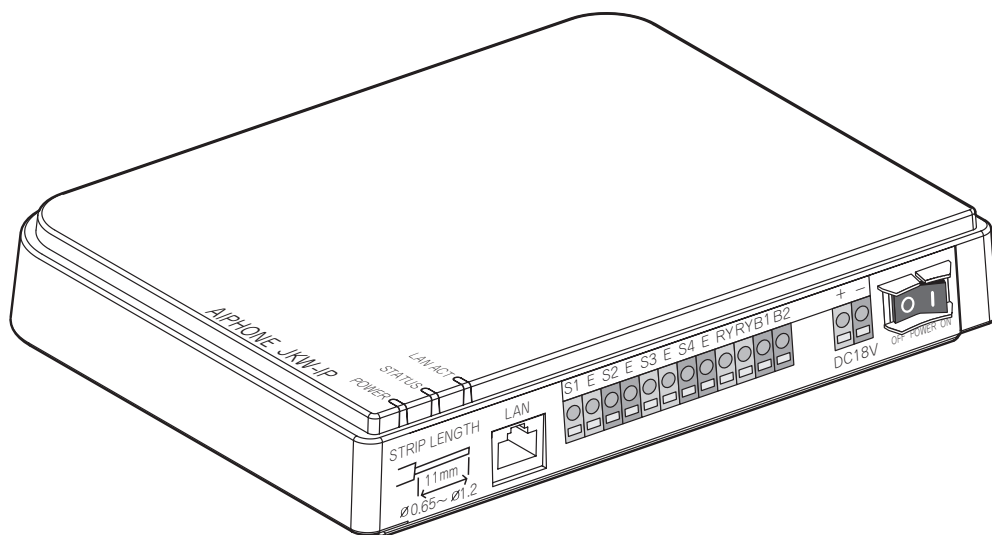

Thank you for selecting Aiphone for your communication needs.

\* Please make sure to read this manual for safe and correct use of the system, and keep this in a safe place for future reference.

Please note that images and illustrations depicted in this manual may differ from the actual product.

# CONTENTS

<b>1 INTRODUCTION .....</b>	<b>6</b>	<b>5 PC Application Basic Operations..</b>	<b>39</b>
<b>1-1</b> System Configuration Example .....	6	<b>5-1</b> Video Intercom Functions .....	39
<b>1-2</b> Names .....	7	5-1-1 Answering a call from the door station...39	
IP Video Intercom Adaptor .....	7	5-1-2 Door release .....	40
PC Application Window .....	8	5-1-3 Zoom/Wide, Pan & Tilt.....	41
<b>1-3</b> About System Settings.....	10	5-1-4 Adjust image .....	42
<b>1-4</b> Starting up the IP Video Intercom Adaptor .....	12	5-1-5 Room-to-room communication (Communication with a master monitor station) ..	42
<b>1-5</b> Installing the PC Application .....	12	5-1-6 Entrance monitoring.....	44
1-5-1 System Requirements.....	12	5-1-7 Sensor Detection from Connected Equipment.....	45
1-5-2 Installing.....	13	5-1-8 Option Output from IP Video Intercom Adaptor.....	45
1-5-3 Uninstalling .....	15	5-1-9 Balloon Notification .....	45
1-5-4 Starting up the PC Application.....	15	<b>5-2</b> Recording Function .....	46
<b>2 Network Settings.....</b>	<b>16</b>	5-2-1 Auto Recording .....	46
<b>2-1</b> PC Network Settings.....	16	5-2-2 Manual recording .....	47
<b>2-2</b> Connecting the PC of the person setting up the network and the IP Video Intercom Adaptor .....	17	<b>5-3</b> Playback Function .....	48
<b>3 IP Video Intercom Adaptor Settings .18</b>		5-3-1 Play recorded image .....	48
<b>3-1</b> Registering the IP Video Intercom Adaptor .....	18	5-3-2 Deleting a Recorded File .....	49
<b>3-2</b> Logging in .....	20	<b>5-4</b> Sending Email.....	49
<b>3-3</b> Administrator Settings .....	21	<b>6 Others.....</b>	<b>50</b>
3-3-1 Administrator Registration.....	21	<b>Technical Precautions .....</b>	<b>52</b>
3-3-2 User Registration .....	22	<b>Specifications.....</b>	<b>52</b>
3-3-3 Email Setting (IP Video Intercom Adaptor) ...	23	<b>Settings Information Memo.....</b>	<b>53</b>
3-3-4 Sensor input / Option output Settings..	24	<b>Example of Registration .....</b>	<b>54</b>
3-3-5 Network Settings.....	26	<b>Regulations.....</b>	<b>56</b>
3-3-6 Log Downloading / Firmware Update...29		<b>Warranty.....</b>	<b>56</b>
<b>3-4</b> User Settings .....	32		
3-4-1 Downloading Encryption Key .....	32		
3-4-2 Email Setting.....	33		
<b>4 PC Application Settings .....</b>	<b>35</b>		
<b>4-1</b> Setting the PC Application .....	35		
4-1-1 Volume Settings.....	35		
4-1-2 Preferences Settings .....	36		

# PRECAUTIONS



Warning and Caution



General Prohibitions



Prohibition to Dismantle the Unit



Prohibition on Subjecting the Unit to Water



General Precautions

## WARNING

**Negligence could result in death or serious injury.**

- ⊘ 1. Do not dismantle or alter the unit. Fire or electric shock could result.
- ⊘ 2. High voltage is present internally. Do not open the case. Electric shock could result.
- ⊘ 3. Do not connect any non-specified power source to the +, - terminals. Also, do not install two power supplies in parallel to a single input. Fire or damage to the unit could result.
- ⊘ 4. Do not connect any terminal on the unit to an AC power line. Fire or electric shock could result.
- ⊘ 5. Do not use power supply with a voltage other than specified. Fire or electric shock could result.
- ⊘ 6. Keep the unit away from water or any other liquid. Fire or electric shock could result.
- ⊘ 7. Do not put any metal or flammable material into the unit through the openings. Fire, electric shock, or unit trouble could result.

## CAUTION

**Negligence could result in injury to people or damage to property.**

- ⊘ 1. Do not install or make any wire terminations while power supply is plugged in. It can cause electrical shock or damage to the unit.
- ⓘ 2. When mounting the unit on a wall, install the unit in a convenient location, but not where it could be jarred or bumped. Injury could result.
- ⓘ 3. Before turning on power, make sure wires are not crossed or shorted. If not, fire or electric shock could result.
- ⊘ 4. Do not install the unit in locations subject to frequent vibration or impact. It may fall or tip over and possibly damage the unit.
- ⓘ 5. For power supply, use Aiphone power supply model or model specified for use with system. If non-specified product is used, fire or malfunction could result.
- ⊘ 6. Do not put anything on the unit or cover the unit with cloth, etc. Fire or unit trouble could result.
- ⊘ 7. Do not install the unit in any of the following locations. Fire, electric shock, or unit trouble could result.
  - \* Places under direct sunlight or places near heating equipment that varies in temperature.
  - \* Places subject to dust, oil, chemicals, etc.
  - \* Places subject to moisture and humidity extremes, such as bathrooms, cellars, greenhouses, etc.
  - \* Places where the temperature is quite low, such as inside a refrigerated area or in front of an air conditioner.
  - \* Places subject to steam or smoke (near heating or cooking surfaces).
  - \* Where noise generating devices such as dimmer switches or inverter electrical appliances are close by.

## General Precautions

1. Keep the unit more than 1 m away from radio or TV set.
2. Keep the intercom wires at least 30 cm (12") away from AC 100-240 V lines. Noise and malfunction could result.
3. Install the unit in an area that will be accessible for future inspections, repairs, and maintenance.
4. As to other manufacturer's devices (such as sensor, detectors, door releases) used with this system, comply with the Specifications and Warranty conditions that the manufacturers or vendors present.
5. This unit is for indoor use only. Do not use outdoors.
6. If the unit is down or does not operate properly, unplug the power supply or turn off the POWER switches.
7. When wall-mounted, the top of the unit may darken. This does not indicate a malfunction.
8. The unit case may become warm with use, but this is not a unit malfunction.
9. If a cellular phone is used close by, the unit may malfunction.
10. The unit can be damaged if dropped. Handle with care.
11. The unit turns inoperative during power failure.
12. In areas where broadcasting station antennas are close by, the intercom system may be affected by radio frequency interference.

## Notes on Usage

- The times for the master monitor station and the PC Application are not synchronized.
- Lip-sync is not performed for audio and video in the PC Application.
- Depending on the network environment and computer, it may not be useable.
- There are times when audio and video may be delayed in the PC Application due to encoding, decoding, or the network.
- Start the IP Video Intercom Adaptor (turn on the power) only after you have connected all cables, such as wires or LAN cables, to the master monitor station correctly. In particular, when the power for the master monitor station is turned on after the IP Video Intercom Adaptor has started, an error sound may be generated on the computer if the PC Application cannot connect to the master monitor station. Also, turn off the power for the IP Video Intercom Adaptor before disconnecting any cables from the Adaptor.
- The ID/Password to access the IP Video Intercom Adaptor is the customer's responsibility. Make sure you set a password that cannot be easily guessed by a third party. We recommend that you change the ID/Password on a regular basis.
- Depending on the broadband router, it may not operate. Check our website (<http://www.aiphone.net/>) for a list of supported broadband routers.
- If you cannot access the IP Video Intercom Adaptor, or if a problem occurs such as Email not being received correctly, turn the power to the IP Video Intercom Adaptor off and then on again, and restart the main unit. If this does not fix the problem, restart the modem or broadband router, and then restart the IP Video Intercom Adaptor.
- See the Installation & Operation Manuals provided with the Video Intercom for connection and operation procedures.
- Depending on the network environment or the computer's performance, operations may not be carried out normally, such as interrupted audio or video, and delayed frame rate decrease.
- You need a broadband connection to use this product over the Internet. Also, the broadband router needs a Static Global IP Address.
- We recommend a 100BASE-TX wired LAN network.
- We do not recommend using a wireless LAN as it may not operate correctly due to security issues or communication speed delays.
- When operating PC Application in succession, the operation may become invalid.
- In the event of a power breakdown or when the IP Video Intercom Adaptor is restarted, operation of PC Application is invalid for approximately 5 minutes.
- Use "Settings Information Memo" in page 53 and record your settings information. It will need when resetting or maintenance.

## Notes on Usage (Communication)

- To talk, listen, etc. using the PC Application, connect a commercially available stand microphone and speaker, etc. to the computer. When a conversation cannot be switched properly between yourself and the target side, adjust the microphone and/or speaker volume on the PC Application. If the adjustment is insufficient, also adjust the volume of the stand microphone or speaker. If you wish to use a headset or handset, please select one with a USB interface.
- If there are loud noises (such as children crying, music playing, or strong winds) around the computer or the door station, the sound may break up and be difficult to hear.
- During communication with the door station, if you speak before the other person has finished talking, your voice may not come through clearly. Communication will proceed smoothly if you wait until the other person has finished before speaking.
- A hands-free (VOX) system has been implemented for communication. Even if you use a headset with the PC Application, you cannot carry out simultaneous conversations. (Communication is not full duplex.)
- The talk and call tone volumes vary depending on the PC Application settings, computer settings, and headset volume. Pay careful attention to the volume when monitoring or talking.

## Notices

- We will under no conditions be liable for damage that occurs due to failures in network equipment; failures due to internet providers and cell phone companies; failures such as disconnected lines and other losses in communication, which render it impossible to provide this service or in any way delay this service due to causes outside of our responsibility; or if an error or missing data occurs during transmission.
- We will under no conditions be liable for damage that occurs due to the inability to communicate due to malfunctions, problems, or operational errors in this product.
- We will under no conditions be liable for damage caused if a customer's password or transmitted information are leaked through bugging or unlawful computer access over Internet communication.
- We will under no conditions be liable for any damages or losses resulting from this product's contents or specifications.
- This manual was created by Aiphone Co., Ltd., all rights reserved. Copying a part of or this entire manual without prior permission from Aiphone Co., Ltd. is strictly forbidden.
- Please note that images depicted in this manual may differ from the actual images due to the version of OS and/or Internet Explorer. etc.
- Please note that this manual may be revised or changed without prior notice.
- Please note that product specifications may be changed for the sake of improvement without prior notice.
- Please be aware that it is the customer's responsibility to ensure that their computer is secure. We will under no conditions be liable for security failures.
- This system is not intended for life support or crime prevention. It is just a supplementary means of conveying information. Aiphone will under no conditions be liable for loss of life or property which occurs while the system is being operated.
- When the IP Video Intercom Adaptor is initialized, all the registrations are returned to factory default settings. Follow the setup procedure for the IP Video Intercom and the PC Application again.

# 1 INTRODUCTION

## 1-1 System Configuration Example

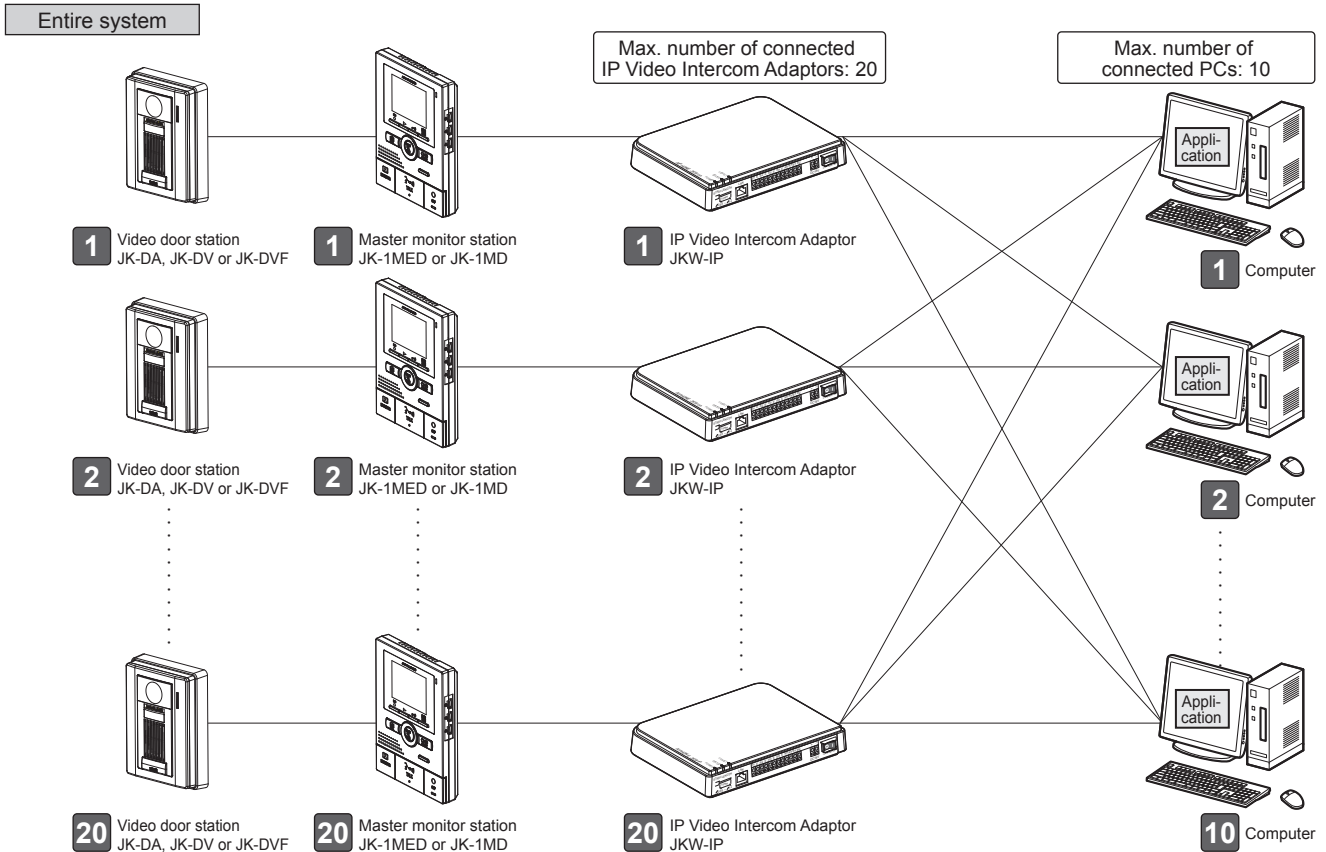
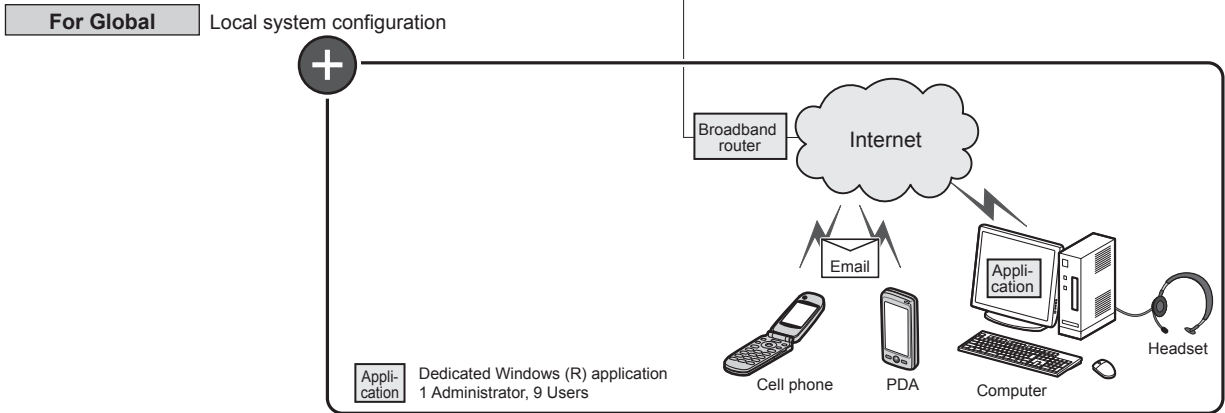
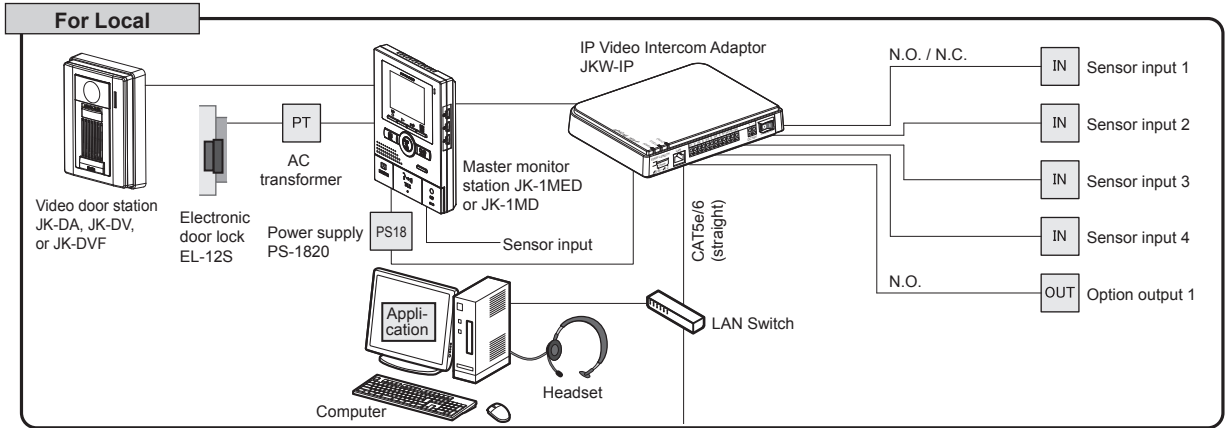

# 1-2 Names

## IP Video Intercom Adaptor

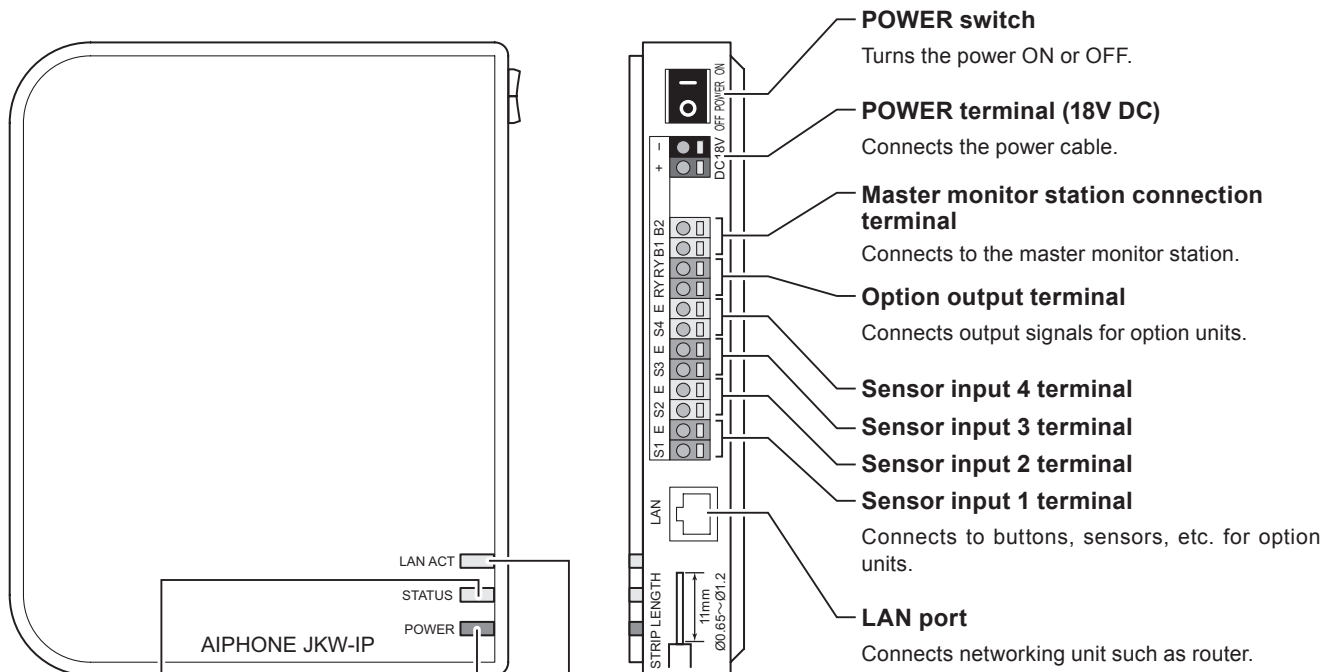

**Default setting switch (within the sticker area)**  
When pressed for 5 seconds or more, IP Video Intercom Adaptor settings are returned to their factory default settings.

### Indicator operation summary

Indicator	Description
<b>LAN ACT indicator (Orange)</b>	Lit • Normal operation (When connected to network)
	Blinking • Exchanging information with LAN port
	Off • Network connection abnormality
<b>STATUS indicator (Orange)</b>	Lit • Normal operation
	Blinking • Starting up • When the default setting switch is pressed and held for 5 seconds or more
<b>POWER indicator (Green)</b>	Lit • Power is on
	Blinking • Abnormality in communication with master monitor station
	Off • Power is off

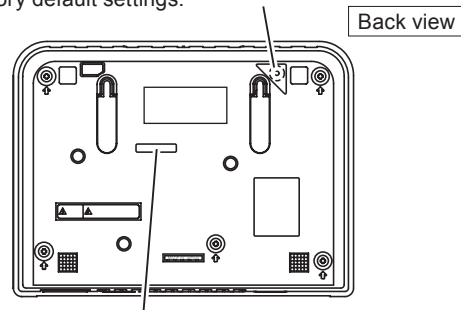

**MAC Address (Do not remove.)**

Never press the default setting switch unless it is necessary. The registered settings will return to the default (factory) settings.

## PC Application Windows

The PC Application window consists of a "Standard Window" and an "Expanded Window". You can switch between the Standard Window and the Expanded Window by clicking the [Standard window] or [Expand window] button.

### Standard Window

In the Standard Window, you can perform the following setting operations.

#### [SENSOR] display

Displays the status of incoming signal(s) from option unit(s)

P.45

#### Screen

Displays images from the door station

#### [MESSAGE] display

Displays a message when a function is operated

Message List
<Adaptor Name>
<Adaptor Name> CALL FROM DOOR <Door station No.>
<Adaptor Name> DOOR <Door station No.> COMMUNICATING
<Adaptor Name> DOOR <Door station No.> MONITORING
CALLING ROOM STATION
<Adaptor Name> CALL FROM ROOM STATION
<Adaptor Name> COMMUNICATING WITH ROOM STATION
<Adaptor Name> EXTERNAL INPUT
<Adaptor Name> EXTERNAL INPUT <No.>
<Adaptor Name> CALLING ROOM STATION
<Adaptor Name> SYSTEM IS IN USE

#### [OPTION] button

Operates option unit

P.45

#### [Pan & tilt] button

Operates Pan & Tilt on the Zoom screen

P.41

#### [CALL] button

Calls the master monitor station

P.43

#### [MONITOR] button

Displays images from the door station on the screen

P.44

#### [TALK] button

Starts communication  
Shortcut key: [Space]

P.39 to 40

#### [Rec / Stop] button

Records the displayed image on the hard disk drive (HDD)  
Stops recording

P.46 to 47

#### [Open play window] button

Plays back images recorded on the PC

P.48

#### [Minimize] button

Minimizes the PC Application window

#### [Expand window] button

Switches to the Expanded Window

#### [Close] button

Closes the PC Application

#### Date Display

Displays the date set in the computer

#### [ZOOM / WIDE] button

Switches the door station image between wide and zoom

P.41

#### [Door release] button

Releases the electronic door lock

P.40

#### [ADJUST] button

Adjusts the image to make it easier to see when there is backlight in the day or when it is dark

P.42

#### [OFF] button

Turns off Talk, Monitor, and Call  
Shortcut key: [Esc]

P.39 to 45

#### [PC SETTING] button

Opens the PC Application Settings window

P.35 to 38

#### Version Display

Displays the PC Application version



MEMO • This is the screen displayed after registration.



### Expanded Window

The following explains the various buttons in the Expanded Window and the display contents.  
The content on the left-hand side of the window is the same as the Standard Window.

#### [Adaptor] display

Displays the IP Video Intercom Adaptor Name  
If no name is set, the MAC Address is displayed

#### [No] display

Displays the IP Video Intercom Adaptor number  
Selects the IP Video Intercom Adaptor

#### [Status] display

Displays the IP Video Intercom Adaptor status

Color	Comment	Description
Red	1 CALL DOOR	Displayed when there is a call from the door station
Green	COMMUNICATION	Displayed during communication
Green	MONITOR	Displayed during monitoring
Orange	1 CALL ROOM ST	Displayed when there is a call from the master monitor station
Orange	CALL	Displayed when there is a call from the PC Application
Gray	<No display>	Encryption key not acquired (During standby)
Blue	<No display>	Displayed during standby

With Windows 7, 8, 8.1, 10 the color of the program displayed in the taskbar changes linked with the [Status].

#### [Standard window] button

Switches to the Standard Window

P.8

#### [Sensor] display

Displays the status of incoming signals from option unit(s)

Color	Description
1 Blue	Sensor input 1 active
2 Blue	Sensor input 2 active
3 Blue	Sensor input 3 active
4 Blue	Sensor input 4 active
M Blue	Master monitor station sensor input active

P.45

#### [SETTINGS] button

Opens the settings window for the IP Video Intercom Adaptor

P.20

#### [▼▲] buttons

Changes the order of the IP Video Intercom Adaptor display

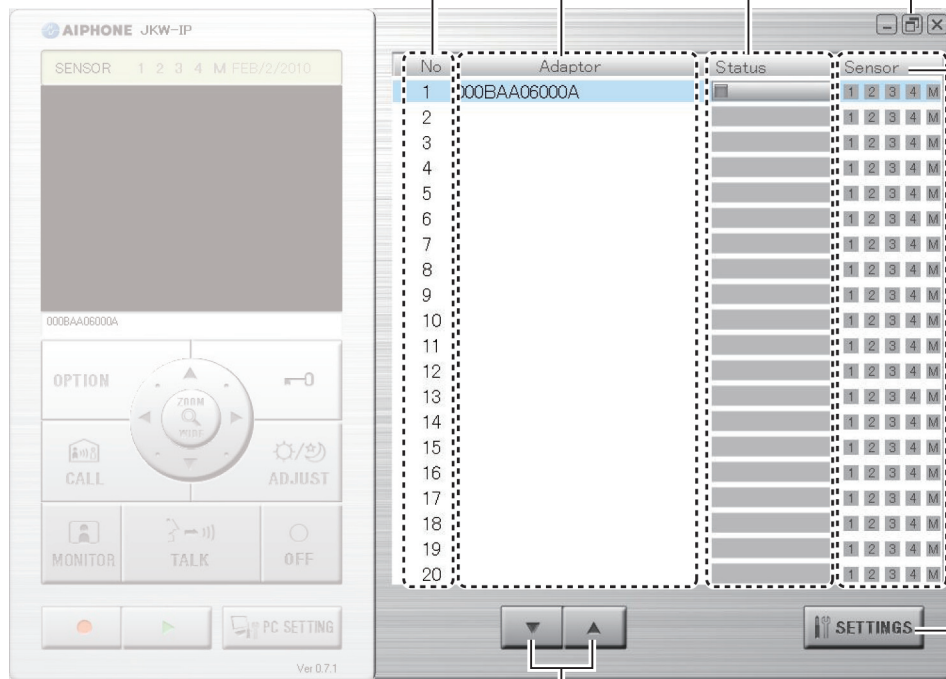

#### MEMO

- You can select the corresponding IP Video Intercom Adaptor by clicking the line for the optional IP Video Intercom Adaptor. Clear the selection by clicking the selected IP Video Intercom Adaptor again.
- Status display cannot indicate the usage status of other PC Applications.
- To delete an IP Video Intercom Adaptor, move the mouse's pointer to the IP Video Intercom Adaptor you want to delete in the "disconnected" status, right-click, and then select "Delete".

# 1-3 About System Settings

**MEMO**

- Be sure to check the system configuration before making settings, and then connect the units correctly.
- You need to contact your provider (ISP) to connect to the Internet.
- Before making settings, be sure to obtain necessary information such as the Static IP Address, Email Addresses, and any other necessary information.
- \* The factory default IP address setting of this device is 192.168.0.30. If the same address is already being used for another device, please change the IP address for the other device.



Perform **STEP 1** through **STEP 3** below in order to configure the product settings. The product cannot be used unless the settings have been configured.

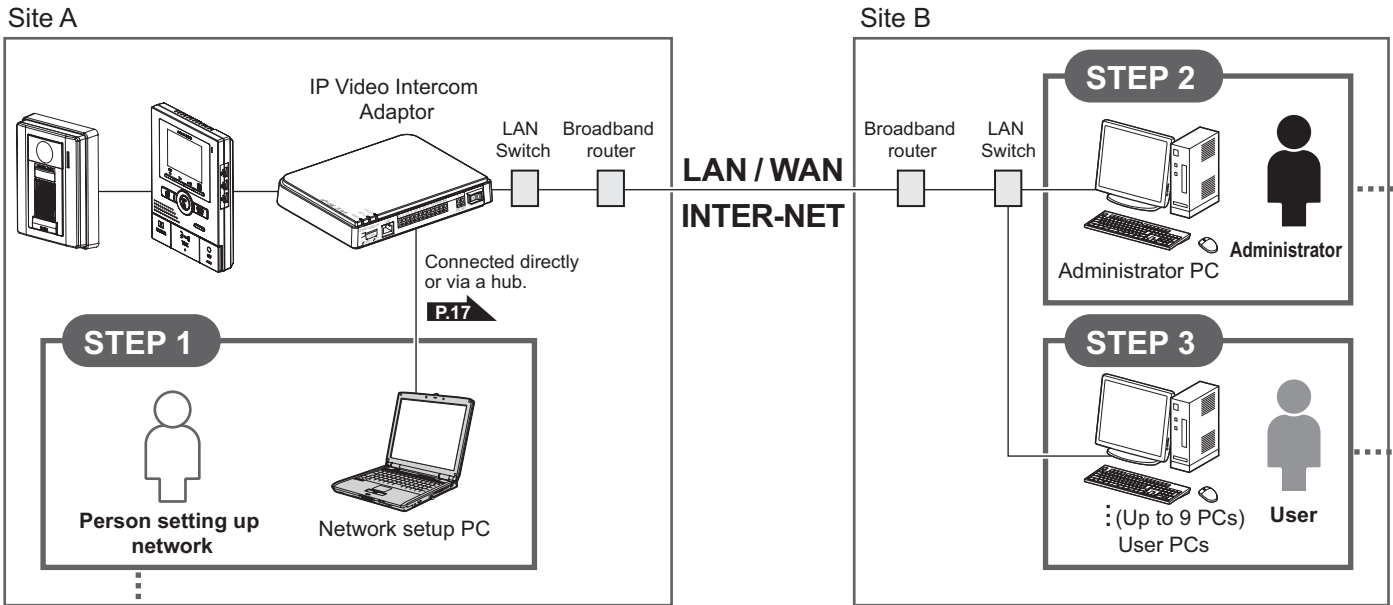

- Settings Information Memo **P.53**
- Example of Registration **P.54**

**STEP 1**

Provisional registration of the IP Video Intercom Adaptor by the person setting up the network

Provisional registration

**1**

**Starting up the IP Video Intercom Adaptor**

Turn on the power of the IP Video Intercom Adaptor and the connected devices.

1-4 Starting up the IP Video Intercom Adaptor **P.12**

**2**

**Installing the PC Application**

Install the PC Application onto the PC of the person setting up the network.

1-5 Installing the PC Application **P.12**

**3**

**Network settings on the PC of the person setting up the network**

Set the IP address on the PC of the person setting up the network.

2-1 PC Network Settings **P.16**

**4**

**Connecting the PC of the person setting up the network and the IP Video Intercom Adaptor**

Connect the IP Video Intercom Adaptor and the PC of the person setting up the network, either directly or via a hub.

2-2 Connecting the PC of the person setting up the network and the IP Video Intercom Adaptor **P.17**

**5**

**Registering the IP Video Intercom Adaptor**

Provisionally register the IP Video Intercom Adaptor in order to configure its settings.

3-1 Registering the IP Video Intercom Adaptor **P.18**

**6**

**Configuring the IP Video Intercom Adaptor network**

Login to the IP Video Intercom Adaptor and configure the network environment.

3-2 Logging in **P.20**  
3-3-5 Network Settings / Connection Settings **P.26**

**STEP 2**

**Registration of the IP Video Intercom Adaptor by the Administrator**

**Registration**

- 1** **Installing the PC Application**  
Install the PC Application onto the Administrator PC.  
1-5 Installing the PC Application **P.12**
- 2** **Administrator PC network settings**  
Set the IP Address on the Administrator PC.  
2-1 PC Network Settings **P.16**
- 3** **Registering the IP Video Intercom Adaptor**  
Register the IP Video Intercom Adaptor in the Administrator PC.  
3-1 Registering the IP Video Intercom Adaptor **P.18**

- 4** **Configuring the IP Video Intercom Adaptor network**  
Login to the IP Video Intercom Adaptor and configure the network environment.  
3-2 Logging in **P.20**  
3-3-5 Network Settings / Connection Settings **P.26**
- 5** **User Registration**  
Register the User ID and User Password.  
3-3-2 User Registration **P.22**

**STEP 3**

**Registration of the IP Video Intercom Adaptor by the User**

**Registration**



- 1** **Installing the PC Application**  
Install the PC Application onto the User PC.  
1-5 Installing the PC Application **P.12**
- 2** **User PC network settings**  
Set the IP address on the User PC.  
2-1 PC Network Settings **P.16**

- 3** **Registering the IP Video Intercom Adaptor**  
Perform registration of the IP Video Intercom Adaptor in the User PC.  
3-1 Registering the IP Video Intercom Adaptor **P.18**

**Operational Settings**

After registration in the Administrator and User PCs is completed, configure the operational settings according to the system configuration and method of administration.

 <b>Administrator</b>	<b>Changing the Administrator settings</b> 3-3-1 Administrator Registration <b>P.21</b>	<b>Email Setting</b> <Sender settings> Set the information to send concerning the Email sender. 3-3-3 Email Setting (IP Video Intercom Adaptor) <b>P.23</b>	<b>Changing the Network Settings</b> <ul style="list-style-type: none"> <li>● Updating the Encryption Key File</li> <li>● Changing the Adaptor Language</li> <li>● Changing the Adaptor Name</li> <li>● Video Setting</li> </ul> 3-3-5 Network Settings <b>P.26</b>
	<b>User Registration</b> 3-3-2 User Registration <b>P.22</b>	<b>Sensor input / Option output Settings</b> 3-3-4 Sensor input / Option output Settings <b>P.24</b>	<b>Log Downloading / Firmware Update</b> 3-3-6 Log Downloading / Firmware Update <b>P.29</b>

 <b>User</b>	<b>Downloading and setting the Encryption Key</b> 3-4-1 Downloading Encryption Key <b>P.32</b>	<b>Email Setting</b> <Target setting> Settings related to sending Email 3-4-2 Email Setting <b>P.33</b>
 <b>Admini- User strator</b>	<b>PC Application Settings</b> Volume Settings 4-1-1 Volume Settings <b>P.35</b>  Preferences Settings 4-1-2 Preferences Settings <b>P.36</b>	

## 1-4 Starting up the IP Video Intercom Adaptor

Provisional registration

Registration : Administrator/User

Use the following steps to start up the IP Video Intercom Adaptor.

1. Check that the wires are connected correctly.
2. Turn on all connected equipment except for the IP Video Intercom Adaptor.
3. Turn on the POWER switch for the IP Video Intercom Adaptor.
  - The POWER indicator (Green) and the LAN ACT indicator (Orange) light, and the STATUS indicator (Orange) blinks.



STATUS indicator  
(Orange) blinking

**MEMO** For more information on the indicators, see "Indicator operation summary" of "IP Video Intercom Adaptor" in "Names". **P.7**

4. The STATUS indicator (Orange) changes to lit.
  - The IP Video Intercom Adaptor is now ready for use.



STATUS indicator  
(Orange) lit

## 1-5 Installing the PC Application

Provisional registration

Registration : Administrator/User

Install the PC Application on your computer from the CD supplied with this product.

You may need to be logged on to your computer as the Administrator to install the PC Application.

### 1-5-1 System Requirements

Your computer must meet the following system requirements to use the PC Application.

Check the Operation Manual supplied with your computer.

OS	Windows XP Home/Professional(SP3), Windows Vista Ultimate/Home/Business/Enterprise(SP1)/32-bit version/64-bit version Windows 7 Home Premium/Professional/Enterprise/Ultimate/32-bit version/64-bit version Windows 8/Pro/Enterprise/32-bit version/64-bit version Windows 8.1/Pro/Enterprise/32-bit version/64-bit version Windows 10 Home/Pro/Enterprise/Education(version1607)/32-bit version/64-bit version
PC system requirements	Processor: 2 GHz or faster System memory (RAM): 1 GB RAM or more Hard disk: 10 MB or more (additional space is needed for recording) Sound card: 8 bit full duplex, Direct Sound compatible Display: 1024 x 768 or greater Run-time: Microsoft .NET Framework 2.0/3.0/3.5 Network: 10BASE-T/100BASE-TX Ethernet
Protocol	TCP/IPv4, UDP/IPv4, SIP, Others
Network bandwidth	320 k to 8 Mbps (per IP Video Intercom Adaptor)
Language	English, French, Spanish, German, Dutch, Italian, Japanese
Internet Explorer	Internet Explorer 6.0 or later (with Internet Options SSL 3.0 enabled)

**!** The PC Application may not run, or may not operate correctly (such as freezes occurring) on a computer with specifications below the necessary requirements.

Serious damage could be caused if an error occurs during door release.

We recommend using a computer that exceeds the basic system requirements.

Microsoft, Windows, and Windows Vista are either registered trademarks or trademarks of Microsoft Corporation in the United States and/or other countries.

**1-5-2 Installing**

This section describes how to install the PC Application into your PC.

- The screens may differ depending on the version of OS and/or Internet Explorer.
- Follow the on-screen instructions to install.

1. Insert the CD-ROM into your computer.

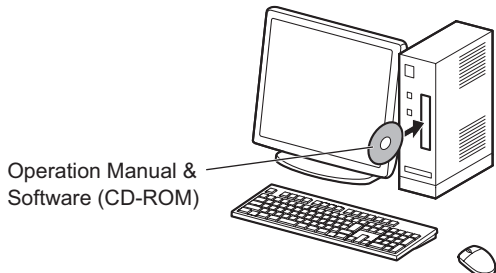

2. Click "English" on the language selection screen.

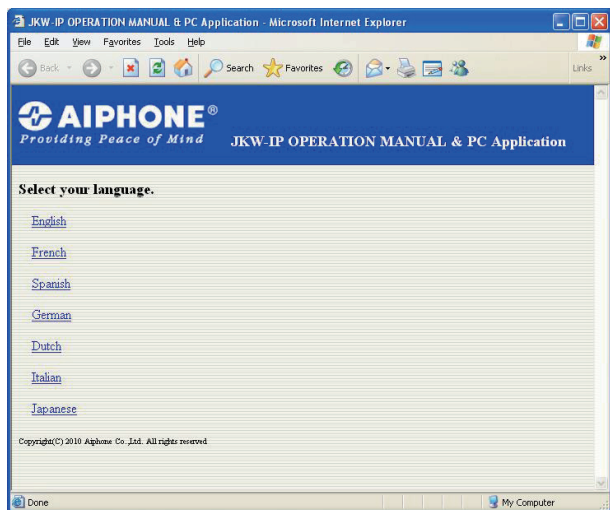

3. Click "PC Application", and then follow the on-screen instructions to install.

- The Aiphone\_JKW Setup Wizard window is displayed.

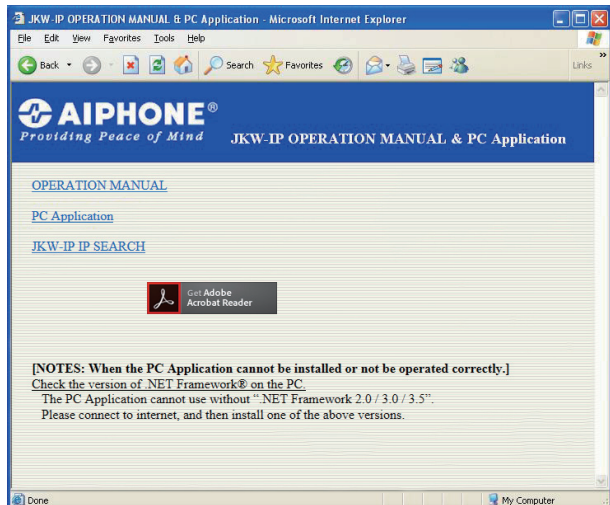

- If ".NET Framework" is not already installed, the .NET Framework installation window is displayed. Follow the on-screen instructions to install.

**MEMO** • When starting up the application, if a security or virus check warning is displayed, please allow the application to continue.

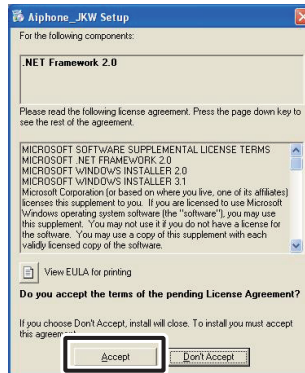

4. Click [Next].

- The Select Options window is displayed.

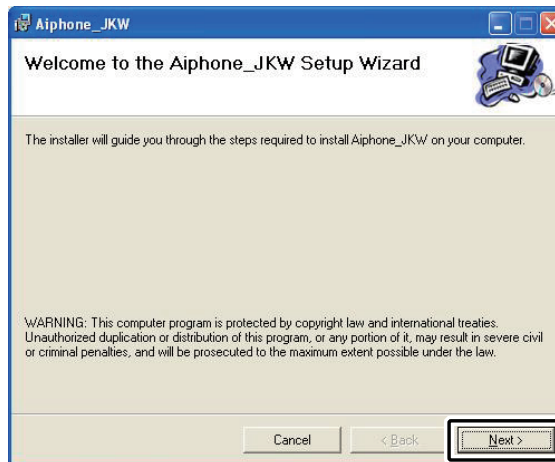

**5.** Click [Next].

- The Select Installation Folder window is displayed.

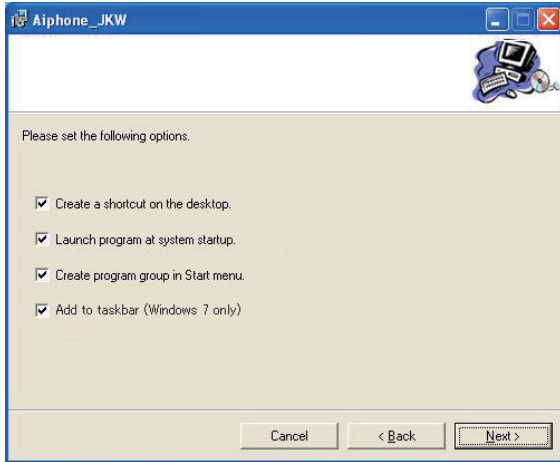

**6.** Click [Next].

- The folder in which the application is to be installed is created.

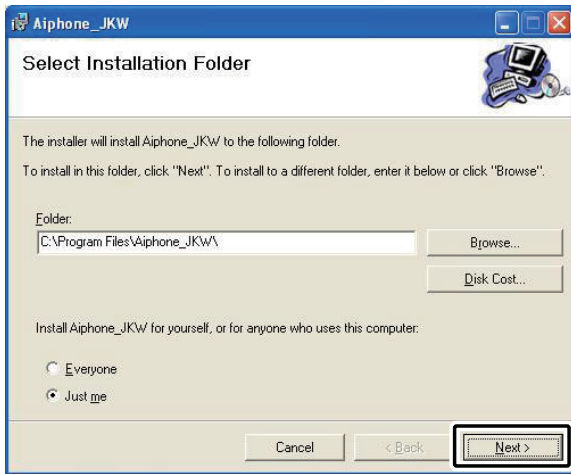

**7.** Click [Next].

- Installation begins.

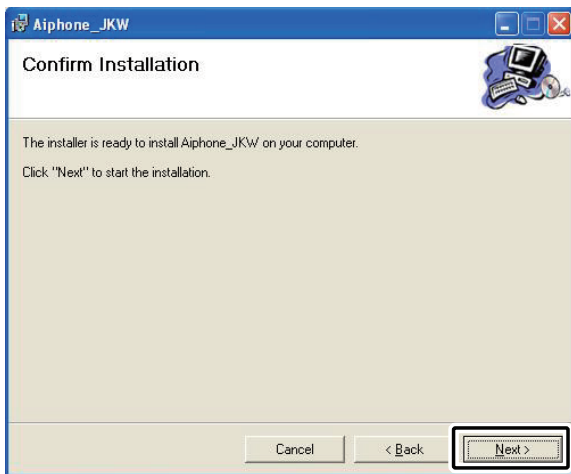

**8.** When the installation is complete, the Select Recording File Storage Folder (Browse for Folder) window is displayed.

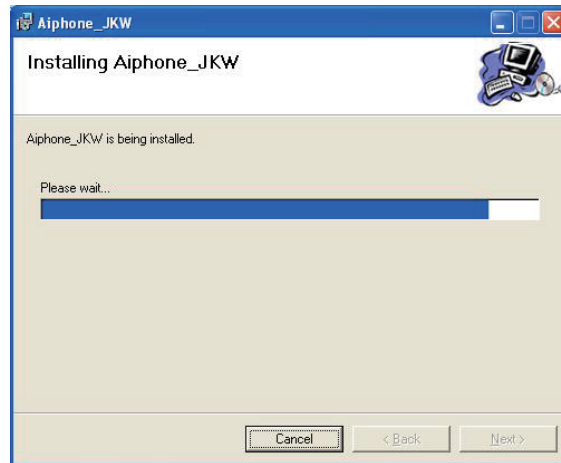

**9.** Select the folder where you want to save recorded files, and then click [OK].

- The selected folder becomes the storage location for recorded files.
- After it is selected, the saved location cannot be changed.



**10.** Click [Close].

- Installation is complete.

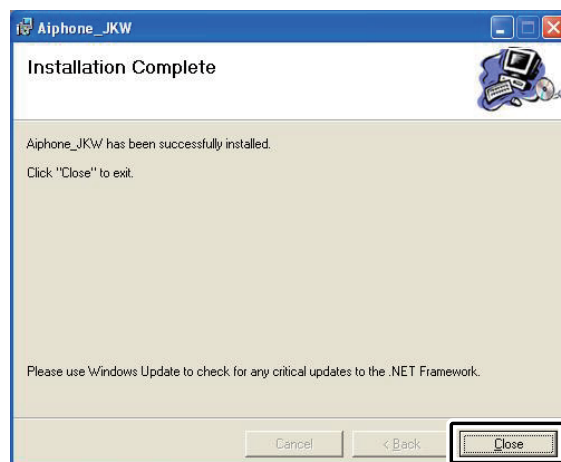

### 1-5-3 Uninstalling

From the Windows "start" menu, select "Control Panel" → "Add or Remove Programs", and select "Aiphone\_JKW" to delete it.

**MEMO** • With Windows 7, the PC Application may still remain on the taskbar after it is deleted. Delete the taskbar application separately.

### 1-5-4 Starting up the PC Application

To start up the PC Application, double-click the

"" icon on the desktop.  
Aiphone\_JKW

You can also start up the PC Application by selecting "Aiphone\_JKW" from the "All Programs" list in the "start" menu. Alternatively, you can run "JKW-IP.exe" from the installation folder (C:\Program Files\Aiphone\_JKW).

When selecting from the "All Programs" list



When running "JKW-IP.exe"

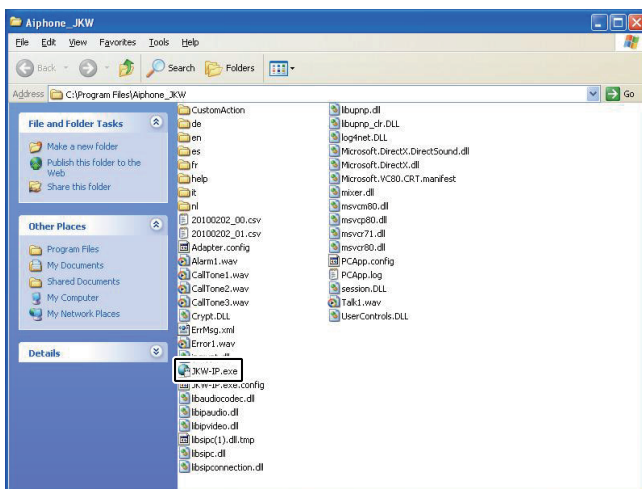

- If another location is specified during installation, run "JKW-IP.exe" from your selected location.

## 2 Network Settings

### 2-1 PC Network Settings

Provisional registration

Registration : Administrator/User

Set the IP Address, Subnet Mask, and other necessary information on the PC of the person setting up the network, the Administrator PC, and the User PCs, according to the network environment.

- From the Windows "start" menu, select "Control Panel" → "Network Connections", then click "Properties" on "Local Area Connection".

• The "Local Area Connection Properties" window appears.

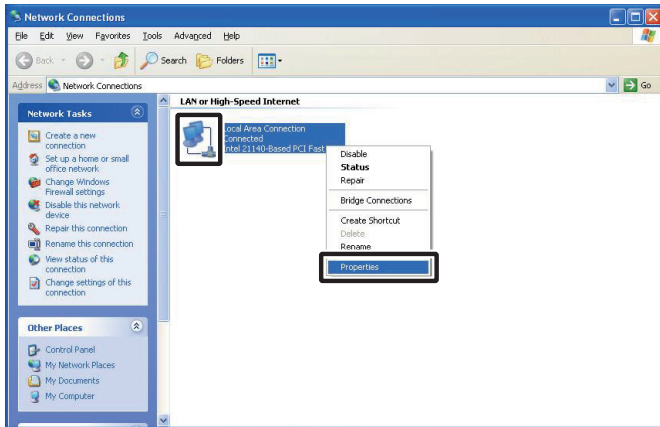

- Select "Internet Protocol (TCP/IP)", then click "Properties".

• The "Internet Protocol (TCP/IP) Properties" window appears.

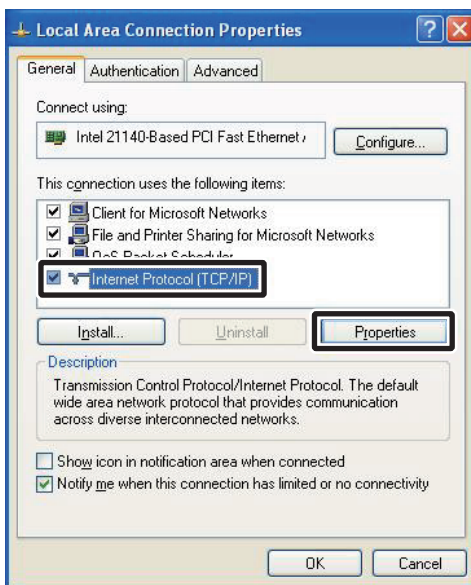

- Enter the IP Address, Subnet Mask, and other necessary information according to the network environment, then click [OK].

• For provisional registration, enter "192.168.0.10" as the IP Address and "255.255.255.0" as the Subnet Mask. All other items besides the IP Address and Subnet Mask may be left blank.

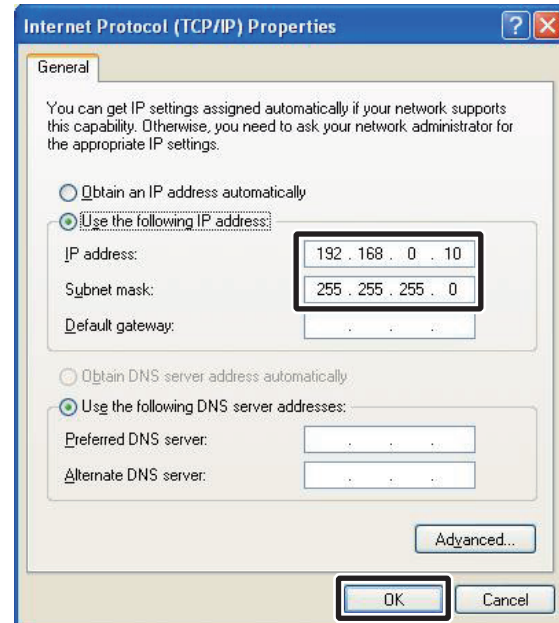

• Click [OK] to return to the "Local Area Connection Properties" window.

- Click [OK].

• The PC Network Settings are now completed.

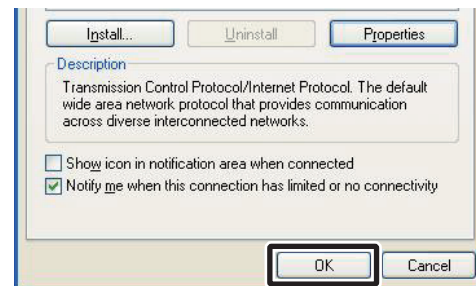

• For provisional settings, after the IP Video Intercom Adaptor settings are completed, be sure to restore the PC network settings to their original status.



**2-2 Connecting the PC of the person setting up the network and the IP Video Intercom Adaptor**

Provisional registration

In order to configure the IP Video Intercom Adaptor, use a LAN cable and connect the PC of the person setting up the network and the IP Video Intercom Adaptor.

When connecting the PC of the person setting up the network directly to the IP Video Intercom Adaptor, use an Ethernet crossover cable. When connecting via a hub, use a straight cable.

Even if it is to be used with Global, first make broadband router settings and Network Settings [P.26 to 28](#) for Global with Local.

Direct connection

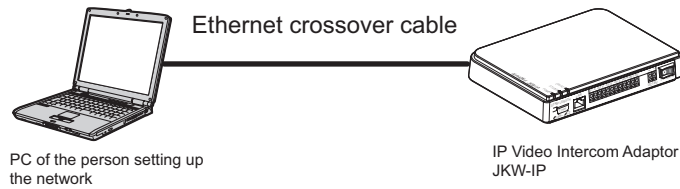

Connecting via a hub

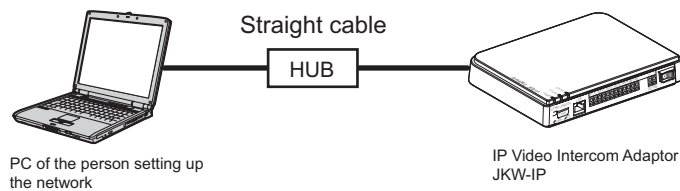

# 3 IP Video Intercom Adaptor Settings

See "Settings List" **P.50** for a list of the IP Video Intercom Adaptor settings.

## 3-1 Registering the IP Video Intercom Adaptor Provisional registration    Registration : Administrator/User

To operate the IP Video Intercom Adaptor, you need to register the IP Video Intercom Adaptor connected to the system.

Register from the Adaptor list on the right-hand side of the Expanded Window. When registration is complete, each IP Video Intercom Adaptor name (the default is the MAC Address) is displayed under "Adaptor" in the Adaptor list. The registered IP Video Intercom Adaptor is automatically recognized the next time the PC Application is started up, and it is displayed in the IP Video Intercom Adaptor list.

**MEMO**

- You can change the IP Video Intercom Adaptor Name and IP Address for each IP Video Intercom Adaptor from Administrator Settings/Network Settings. See "Network Settings" for more details. **P.26**
- Up to 9 Users can be registered for 1 IP Video Intercom Adaptor.

**1.** Start up the PC Application, and display the Expanded Window.

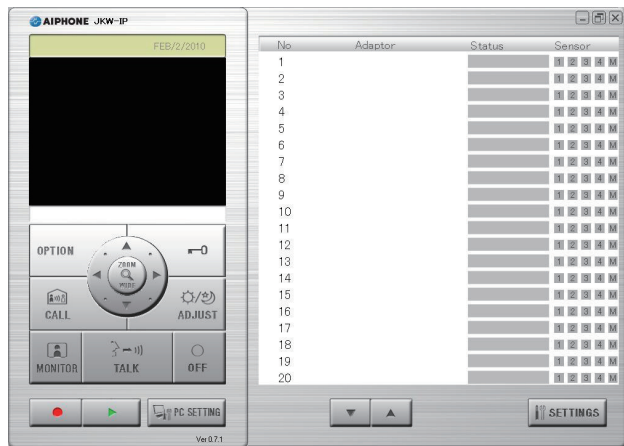

**2.** Select the number where you want to register the IP Video Intercom Adaptor, right-click, and then select "Connect" from the menu displayed.

- The Adaptor Registration window is displayed.

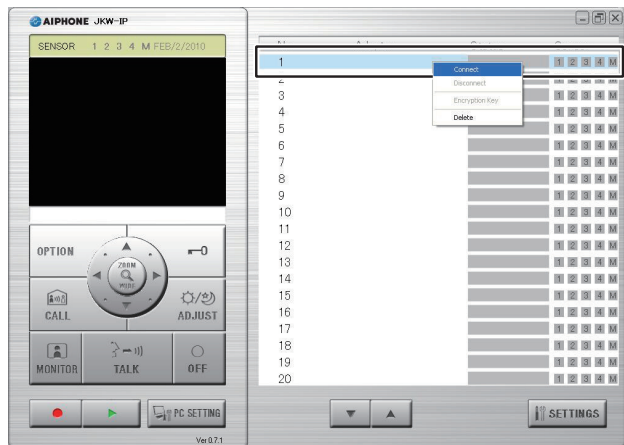

**3.** Enter the unique IP Address, Connection Port, Connection Password, and Web Port for the IP Video Intercom Adaptor to be registered.

- For provisional registration, enter "192.168.0.30" as the IP Address, "aiphone" as the Connection Password. The Connection Port and Web Port may be left at their factory default settings.
- If the Administrator, enter the IP Address, Connection Port, Connection Password, and Web Port that were previously set at the IP Video Intercom Adaptor.
- For a User, obtain the IP Address, Connection Port, Connection Password and Web Port from the Administrator in advance.

**!** Duplicated IP Addresses cannot be set on the same LAN.



- For Global, enter the Global IP Address of the broadband router on the IP Video Intercom Adaptor side as the IP Address.
- You need a Static Global IP Address for the Global IP Address. It does not support DDNS service.
- If you do not know your Local IP Address, run "JKW-IP IP SEARCH" from the CD-ROM supplied, and then click the "Search" button. It searches for the IP Video Intercom Adaptor on the network, and then displays the MAC Address and the IP Address. It is set to 192.168.0.30 at the time of shipping.

**4.** Enter a valid ID and Password.

- If you enter the ID and Password here, you will not have to enter them again when logging into the IP Video Intercom Adaptor.



**MEMO**

- For provisional registration and for the Administrator, enter "aiphone" as the ID, and "aiphone" as the Password. If they are not entered correctly, an ID error will occur for login.
- If a User, the ID and Password that were registered by the Administrator in "User Registration" **P.22** are required.

**5.** Select the optional Network Interface Card (NIC): being used.

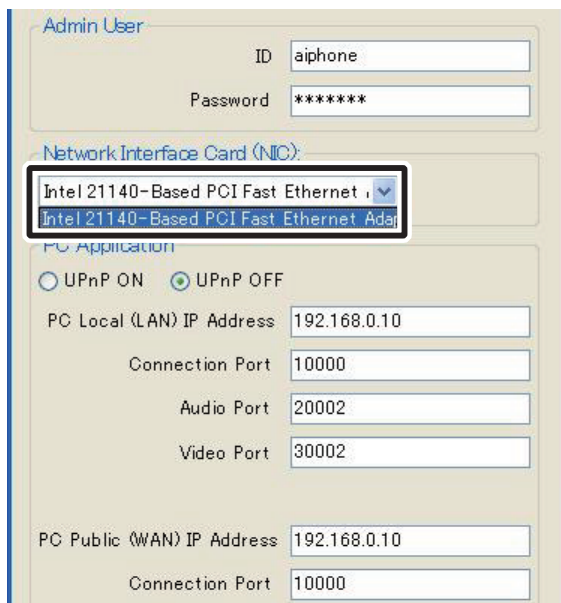

**6.** Select UPnP ON or OFF.

- For provisional registration, select ON and proceed to Step 7.
- For Global, when using a broadband router that is confirmed to support UPnP, select ON.
- For Global, if the broadband router does not support UPnP, or when connecting between networks, select OFF and enter the broadband router information.
- For Local, select OFF and enter the IP Address that was allocated to the PC.

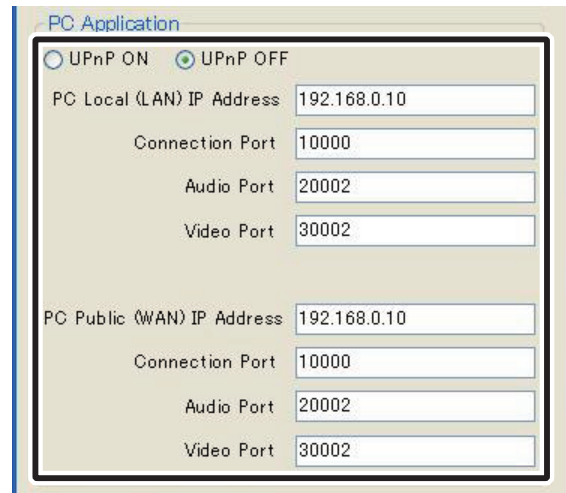

- For Global, it may be necessary to change ports when you are using multiple IP Video Intercom Adaptors or PC Applications. Please check our homepage at <http://www.aiphone.net> for more details.
- For the broadband router setting information, see the Operation Manual supplied with the broadband router.
- You can enter only even values in both the Audio Port and Video Port.

**7.** Click [OK].

- The Adaptor Registration window closes, and the IP Video Intercom Adaptor is registered.

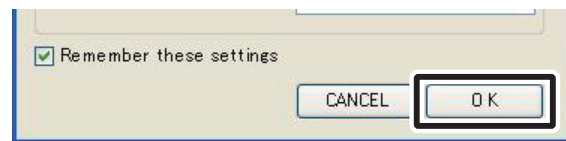

- \*If the check mark is removed, the entered information is not remembered.
- When the IP Video Intercom Adaptor registration is complete, the name of the IP Video Intercom Adaptor is displayed in the [Adaptor] column and an icon (gray) is displayed in the [Status] column.

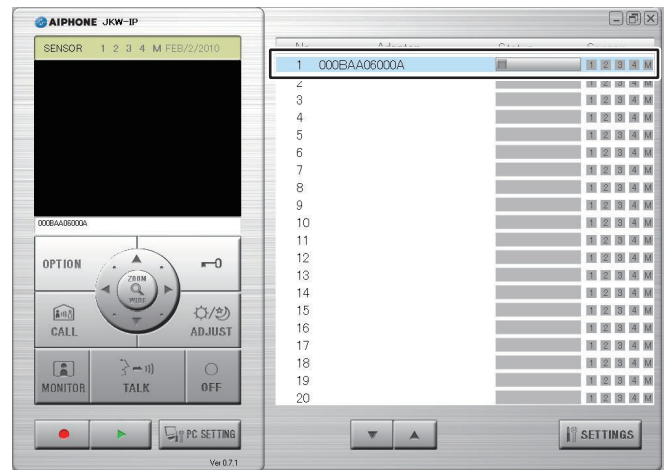

**MEMO**

- To make Adaptor settings, you need to enable SSL 3.0 from Internet Options - Advanced in Internet Explorer 6.0 and later.

## 3-2 Logging in

Provisional registration

Registration : Administrator/User

To modify IP Video Intercom Adaptor settings, you first need to login.

**MEMO** • Since you are not registered as a User before setting up, you can only login as the Administrator.

You can login as the "Administrator" or a "User". Setting items are restricted depending on which you use to login. Login using the following method.

1. Start up the PC Application, and select an optional "Adaptor" from the Expanded Window.

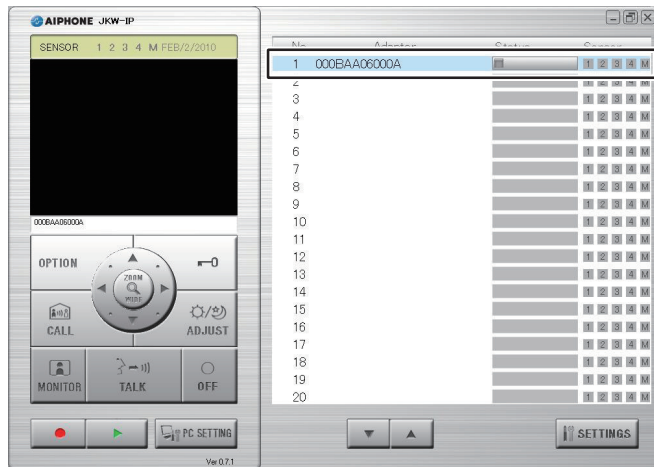

2. Click [SETTINGS].

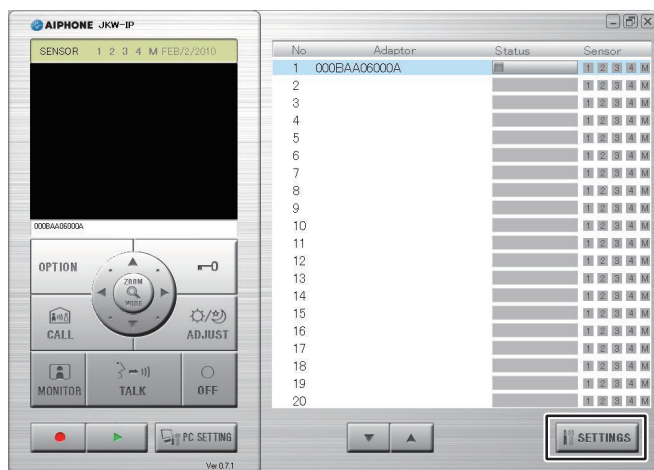

**MEMO** • If the security warning and virus check program warning screens are displayed during start up, please approve them.

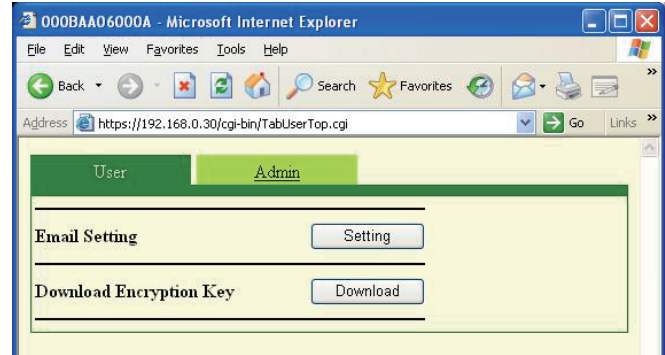

- Login is complete, and the User Settings window is displayed.
- Administrator / User are differentiated by the ID entered.

**MEMO** • If the "Status" display is not displayed, the IP Video Intercom Adaptor is not "connected". Select the relevant IP Video Intercom Adaptor, right-click, and then select "Connect" from the menu displayed to connect the IP Video Intercom Adaptor.

- If the check mark has been removed from "Remember these settings" in the Adaptor Registration window, you need to enter the registration information again. See "Registering the IP Video Intercom Adaptor" [P.18](#) for more details.
- If no operations are performed for a set amount of time after login, timeout automatically occurs. When an operation is next performed, the message "The session has expired. Please login again." is displayed. Login again.
- If the ID and Password were not entered when the IP Video Intercom Adaptor was registered, or if the wrong ID and Password were entered, it will be necessary to enter the ID and Password here.

## 3-3 Administrator Settings

Provisional registration

Registration : Administrator

Various Administrator settings for the IP Video Intercom Adaptor can be made from the Administrator Settings window while logged in as the Administrator.

**MEMO** • You cannot change settings for multiple IP Video Intercom Adaptors at the same time. Make various settings for each IP Video Intercom Adaptor.

The following settings come under Administrator Settings.

Setting Item	Reference
Administrator Registration	P.21
User Registration	P.22
Email Setting (IP Video Intercom Adaptor)	P.23
Sensor input / Option output Settings	P.24
Network Settings	P.26
Log Downloading/Firmware Update	P.29

Use the following method to display the Administrator Settings window.

1. After starting up the PC Application, select an optional "Adaptor", and then login as the Administrator.
  - The User Settings window is displayed.

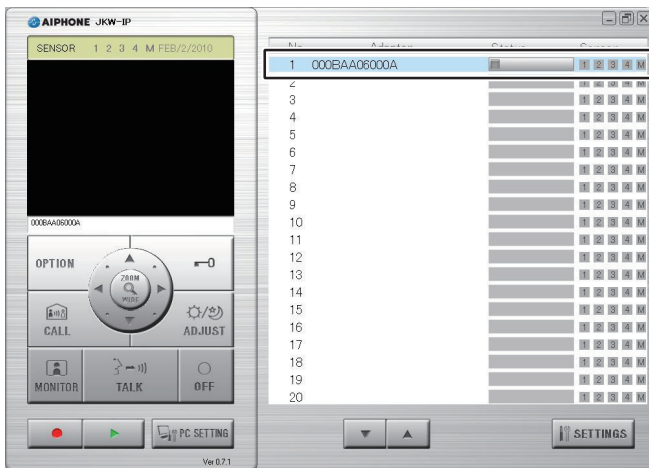

**MEMO** • See "Logging in" for more details on logging in. P.20

2. Click the [Admin] tab.
  - The Administrator Settings window is displayed.

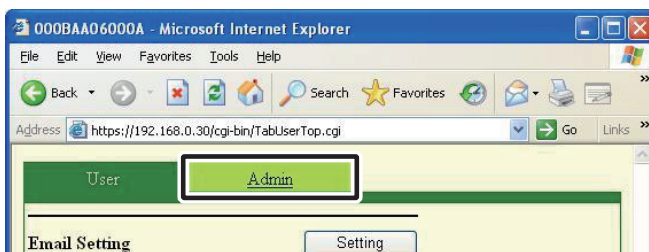

**MEMO** • You cannot select the [Admin] tab when logged in as a User.

### 3-3-1 Administrator Registration

In Administrator Registration, you can change the Administrator ID and Administrator Password.

**!** We recommend changing the default password.

**MEMO** • If you are logged in as a User, you cannot perform Administrator Registration.

1. Click the [Setting] button of "Administrator Registration" from the Administrator Settings window.
  - The Administrator Registration window is displayed.

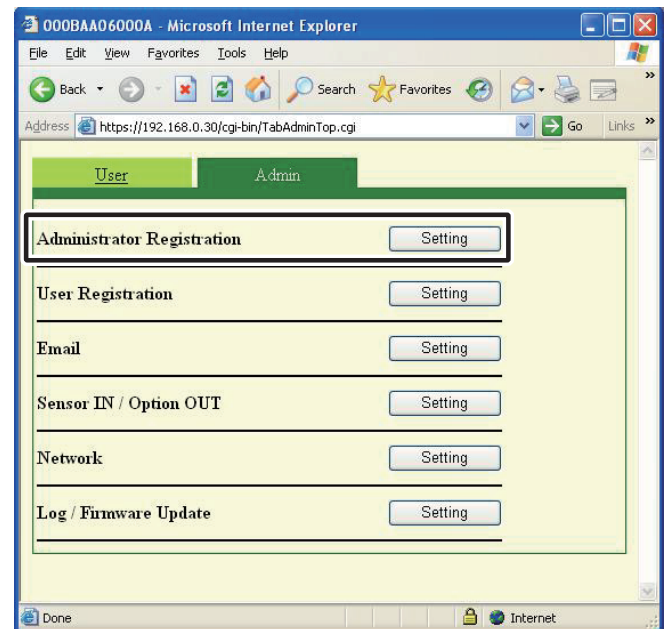

2. Enter the ID and the Current Password.
  - You can enter up to 16 single-byte alphanumeric characters for the ID.



3. Enter a password in New Password.
  - You can enter up to 16 single-byte alphanumeric characters for the password.

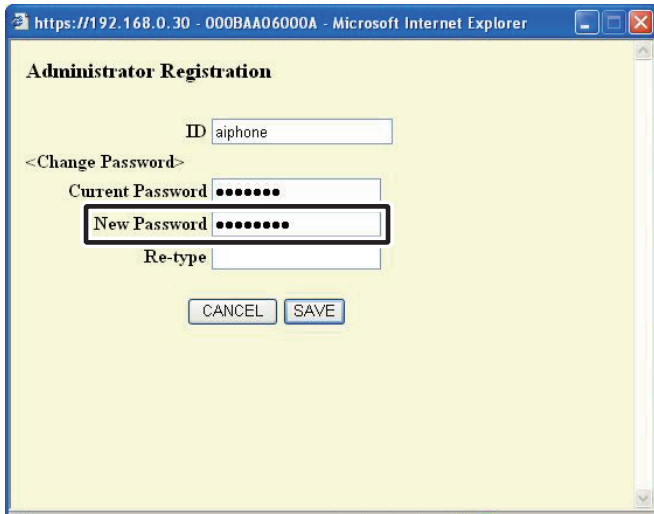

4. Enter the new password again in the "Re-type" field as confirmation.
5. Click [SAVE].
  - "[Administrator Registration] Setting has been saved." is displayed, the entered ID and new password are set, and you are returned to the Administrator Settings window.

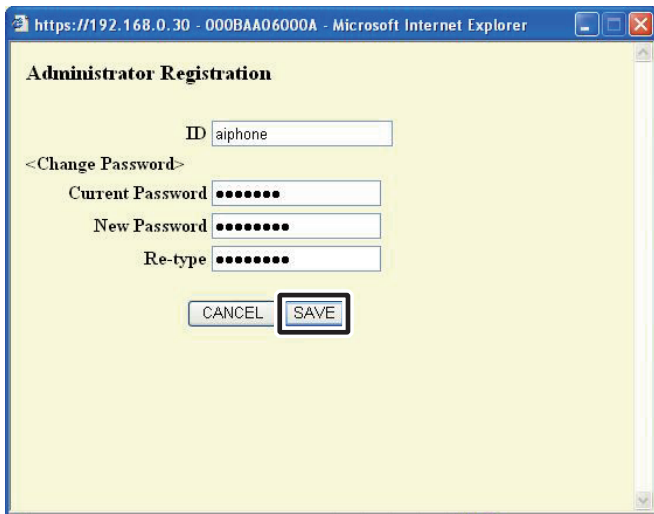

• When you have changed the ID or password Change the ID or password in "Registering the IP Video Intercom Adaptor" **P.18** to the same ID or password.

**MEMO**

- Setting operations are canceled if you click [CANCEL], and you are returned to the Administrator Settings window.
- If you forget the registered ID or password, press the default setting switch of the IP Video Intercom Adaptor for 5 seconds or more to return the factory default settings. However, all settings return to the factory default settings.

### 3-3-2 User Registration Registration : Administrator

Users other than the Administrator can be registered to allow them to use the IP Video Intercom Adaptor. Enter the User ID and User Password in User Registration.

**MEMO**

- If you are logged in as a User, you cannot perform User Registration.

1. Click the [Setting] button of "User Registration" from the Administrator Settings window.
  - The User Registration window is displayed.

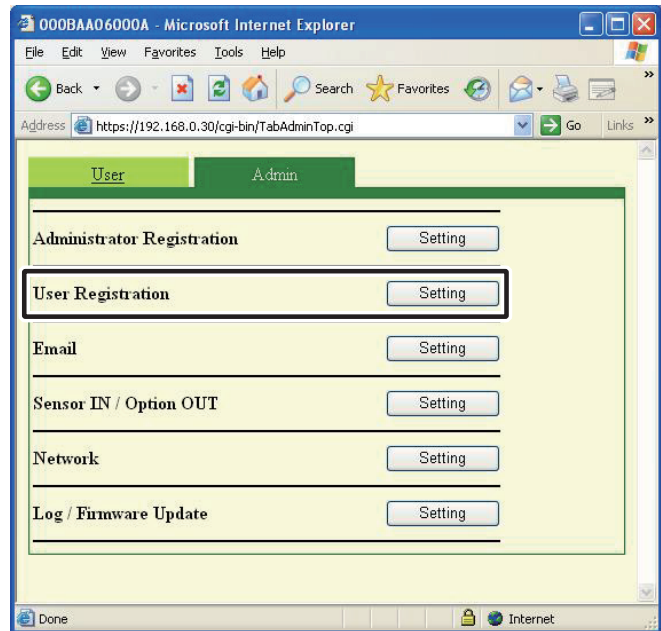

2. Enter the User's ID and Password.
  - You can register up to 9 users.

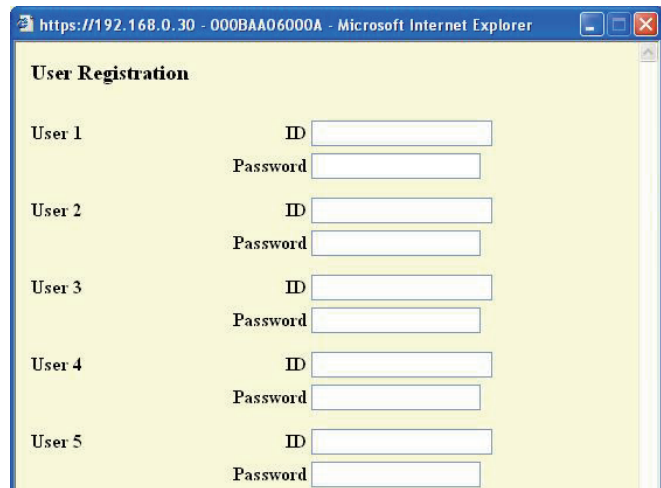

### 3. Click [SAVE].

- "[User Registration] Setting has been saved." is displayed, and you are returned to the Administrator Settings window.

User 7 ID   
Password

User 8 ID   
Password

User 9 ID   
Password

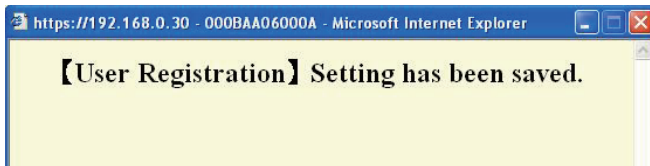

- MEMO**
- Setting operations are canceled if you click [CANCEL], and you are returned to the Administrator Settings window.
  - All settings are returned to their factory default settings if you press the IP Video Intercom Adaptor default setting switch for 5 seconds or more.

### 3-3-3 Email Setting (IP Video Intercom Adaptor)

In Email Setting, you can set information on the origin of the sent Email.

- MEMO**
- If you are logged in as a User, you cannot perform Email Setting.
  - Prepare an Email account for the IP Video Intercom Adaptor beforehand.

#### 1. Click the [Setting] button of "Email" from the Administrator Settings window.

- The Email Setting window is displayed.

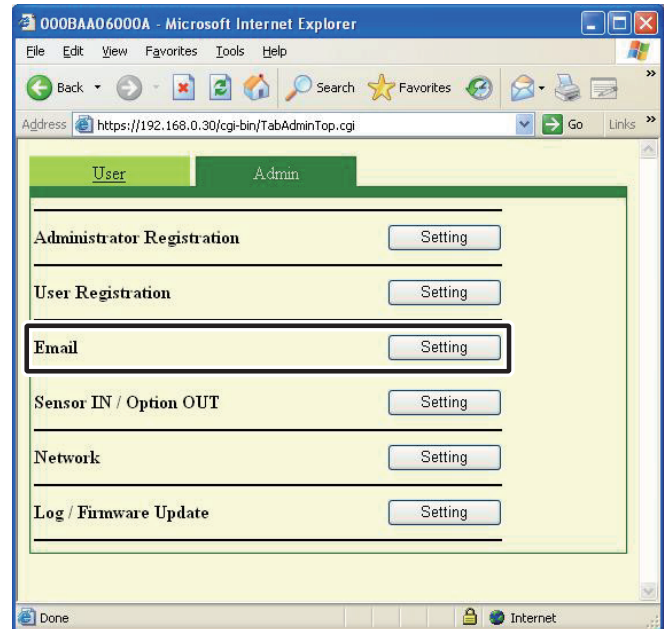

#### 2. Enter information for the "Adaptor Email Address", "SMTP Server", "(Email) login ID", "SMTP Password", "SMTP Server Port", and "SSL"\* based on your Email account information.

- \*For an SSL-dedicated server, select ON.

https://192.168.0.30 - 000BAA06000A - Microsoft Internet Explorer

**Email**

Adaptor Email Address

SMTP Server

(Email) login ID

SMTP Password

SMTP Server Port

SSL  ON  OFF

- MEMO**
- The default SMTP Server Port setting is "465".
  - See **P.51** for the characters and symbols that can be used.

**3.** Click [SAVE].

- "[Email] Setting has been saved." is displayed, the entered Email address is set, and you are returned to the Administrator Settings window.

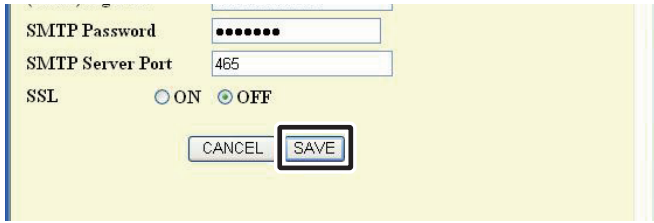

- MEMO**
- Setting operations are canceled if you click [CANCEL], and you are returned to the Administrator Settings window.
  - All settings are returned to their factory default settings if you press the IP Video Intercom Adaptor default setting switch for 5 seconds or more.

**3-3-4 Sensor input / Option output Settings**

In Sensor input / Option output Settings, you can set the Sensor input latch duration and detection method, and select the Option output signal output duration. Sensor input detects the N.C. contact input for "N.C." and detects the N.O. contact input for "N.O.". The factory default settings are – Input latch: "Continuous", Sensor input: "N.O.", and Option output: "3 seconds".

- MEMO**
- If you are logged in as a User, you cannot make Sensor input / Option output settings.

**1.** Click the [Setting] button of "Sensor IN / Option OUT" from the Administrator Settings window.

- The Sensor IN / Option OUT Setting window is displayed.

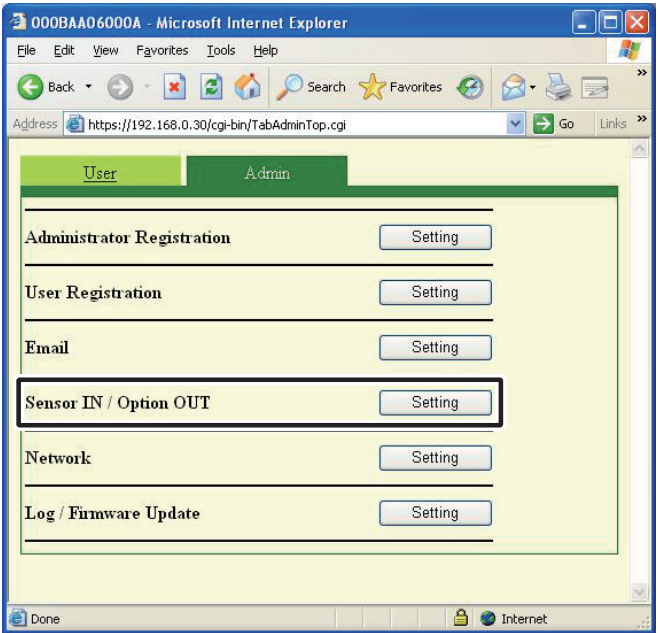



2. Select Input latch and Sensor IN settings between 1 and 4 and make optional settings.

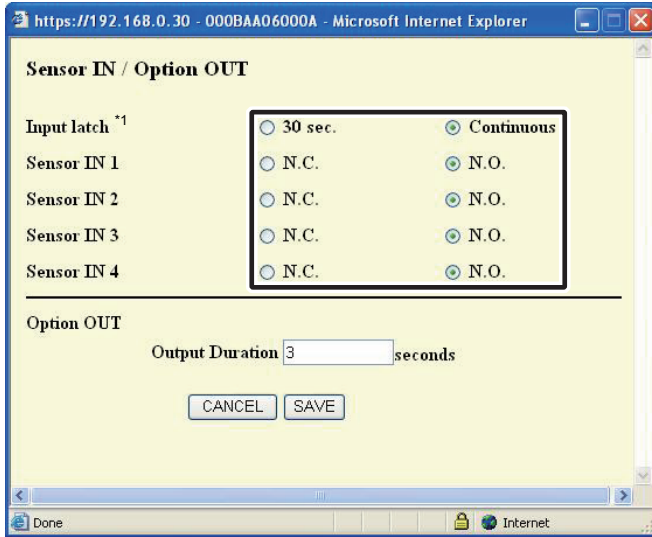

\*1 The following table shows the detection operation of sensor input if the input latch setting of the IP Video Intercom Adaptor is different from the sensor input settings of the master monitor station.

Input latch settings for IP Video Intercom Adaptor	Sensor input settings for master monitor station	Detection operation of sensor input
30 sec.	Continuous	Sensor Detection Tone: 30 sec. [Sensor] display: Continuous
Continuous	30 sec.	30 sec.

3. Enter the Output Duration for Option OUT.

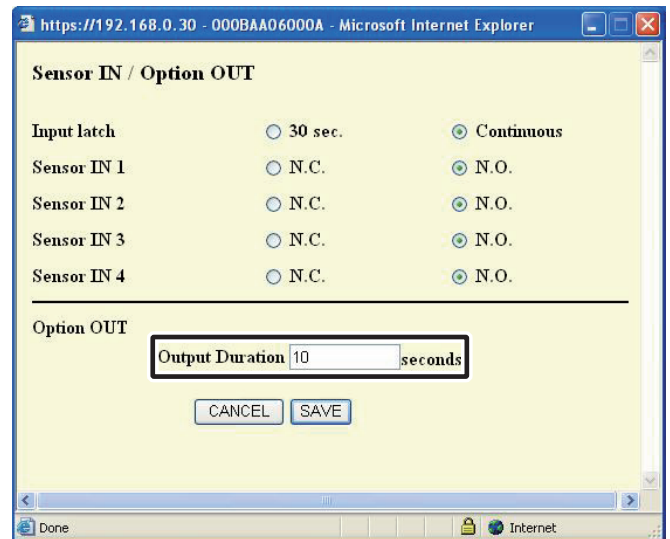

- Set the Output Duration to between 0 and 600 seconds.
- When set to 0 seconds, it is only output when the "OPTION" button is clicked.

4. Click [SAVE].

- "[Sensor IN / Option OUT] Setting has been saved." is displayed, the Sensor input / Option output are set, and you are returned to the Administrator Settings window.

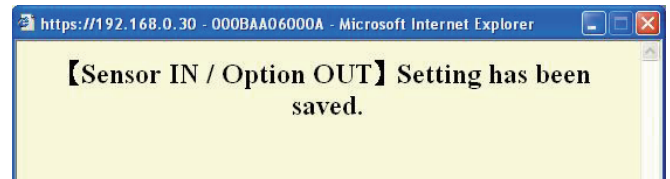
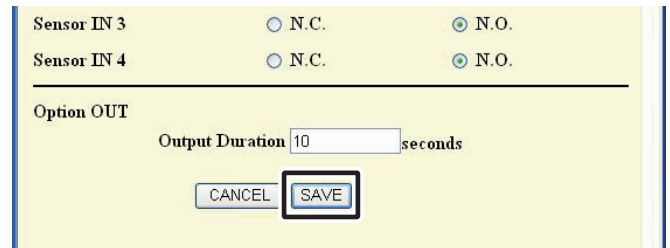

- MEMO**
- Setting operations are canceled if you click [CANCEL], and you are returned to the Administrator Settings window.
  - All settings are returned to their factory default settings if you press the IP Video Intercom Adaptor default setting switch for 5 seconds or more.

### 3-3-5 Network Settings

The following 5 settings come under Network Settings.

- Connection Settings
- Adaptor Name Settings      • Adaptor Language Settings
- Update Encryption Key File   • Video Setting

**MEMO**

- If you are logged in as a User, you cannot make Network Settings.
- Reboot the IP Video Intercom Adaptor if you make Connection Settings changes. If you do not reboot, settings for the IP Video Intercom Adaptor are not changed even though the settings for the PC Application have been changed.
- After restarting, operation of PC application is invalid for approximately 5 minutes. Either wait 5 minutes or perform "Disconnect" and "Connect" of corresponding IP Video Intercom adaptor in PC application.
- When updating the Encryption Key File, you need to download the Encryption Key and make settings for all PC Applications. See "Downloading Encryption Key" for more details. **P.32**

#### Displaying the Network Settings window

You can make various settings from the Network Settings window.

1. Click the [Setting] button of "Network" from the Administrator Settings window.
  - The Network Settings window is displayed.

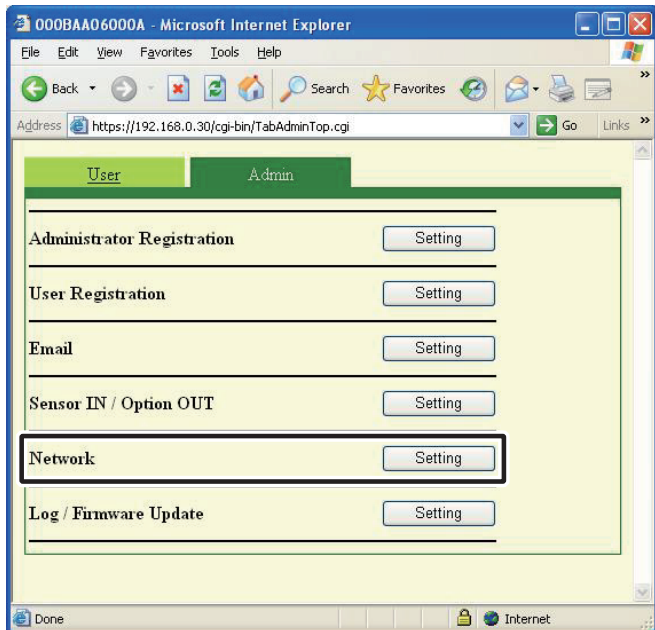

### Connection Settings Provisional registration Registration : Administrator

You can change the Static IP Address setting for the IP Video Intercom Adaptor. The default settings are - IP Address: "192.168.0.30", Subnet Mask: "255.255.255.0", and Default Gateway: "192.168.0.30".

Contact your network Administrator, etc. for information on Static IP Addresses, etc.

1. Select Static IP Address and enter the "IP Address", "Subnet Mask", "Default Gateway", "Primary DNS", and "Secondary DNS".
  - Set "Primary DNS" and "Secondary DNS" if you will send Email.

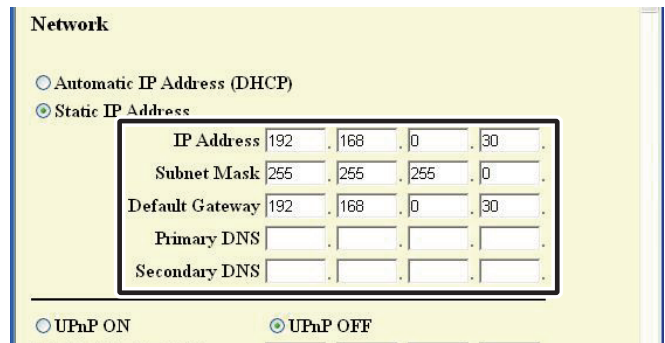

**MEMO**

- You need to set the broadband router to acquire a Static IP Address with DHCP. Depending on the broadband router, some models may not have a setup function.

2. Select UPnP ON or OFF.
  - For Global, if the broadband router does not support UPnP, or when connecting between networks, select OFF and enter the broadband router information.
  - For Global, when using a broadband router that is confirmed to support UPnP, select ON.
  - For Local, select OFF and enter the IP Address that was allocated to the IP Video Intercom Adaptor.

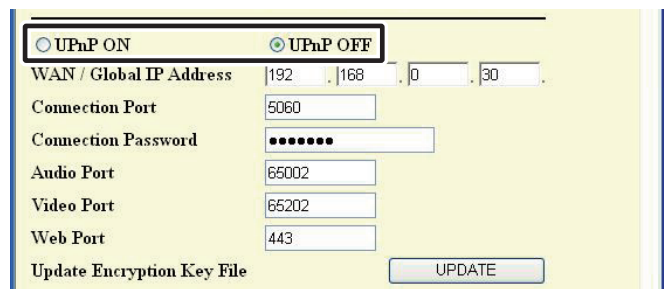

3. Enter the "Connection Port" number, "Audio Port" number, "Video Port" number, and "Web Port" number.
- The factory default setting numbers are - Connection Port: "5060", Audio Port: "65002", Video Port: "65202", and Web Port: "443".
  - For Global, it may be necessary to change ports when you are using multiple IP Video Intercom Adaptors or PC Applications. Please check our homepage at <http://www.aiphone.net> for more details.

- For the broadband router setting information, see the Operation Manual supplied with the broadband router.

4. Click [SAVE].

- "[Network] Setting has been saved." is displayed, and the Reboot Confirmation dialog is displayed.

**MEMO** • Setting operations are canceled if you click [CANCEL], and you are returned to the Administrator Settings window.

5. Click [OK].

- [System is initializing. Please wait. Elapsed Time XX seconds.] is displayed, and the IP Video Intercom Adaptor is rebooted. It takes about 100 seconds to reboot.

- The STATUS indicator blinks. When the STATUS indicator changes to lit, rebooting is complete.
- You can also reboot with the [Reboot] button.

**MEMO** • All settings are returned to their factory default settings if you press the IP Video Intercom Adaptor default setting switch for 5 seconds or more.

## Update Encryption Key File, Adaptor Name Settings, Adaptor Language Settings, Video Setting

### Update Encryption Key File

The door release and option output commands are encrypted. In order to improve security, it is recommended that the Encryption Key File be updated regularly.

1. Click [UPDATE].

- The Update Encryption Key File Confirmation dialog is displayed.

2. Click [OK].

- "The encryption key file has been updated." is displayed.

**MEMO** • After updating the Encryption Key File, it is necessary to re-obtain the Encryption Key and make settings in all the PC Applications. See "Downloading Encryption Key" [P.32](#) for more details.

### Adaptor Name Settings

You can change the name of the IP Video Intercom Adaptor. The "MAC Address" is entered as the default.

1. Enter the "Adaptor Name".

**MEMO** • See [P.51](#) for the characters and symbols that can be used.  
• If a name is not set, the MAC Address is used as the Adaptor Name.

## Adaptor Language Settings

You can select the language used for the IP Video Intercom Adaptor Email transmissions, etc. from "English", "French", "Spanish", "German", "Dutch", "Italian", and "Japanese". The default setting is "English".

1. Click the drop-down menu button for "Adaptor Language", and then select the language.

The screenshot shows the 'Update Encryption Key File' section with an 'UPDATE' button. Below it are fields for 'MAC Address' (00:0B:AA:06:00:0A) and 'Adaptor Name' (000BAA06000A). The 'Adaptor Language' dropdown menu is open, showing options: English, French, Spanish, German, Dutch, Italian, and Japanese. Below the menu are 'CANCEL' and 'SAVE' buttons, and a 'Reboot' button at the bottom left.

## Video Setting

Select the Frame Rate from "1fps", "5fps", "10fps", and "15fps", and select the Quality from "1 (Low)" to "10 (High)". The default settings are - Frame Rate: "15fps", and Quality: "10 (High)".

1. Click the drop-down menu buttons from Video Setting for "Frame Rate" and "Quality", and make the settings.

The screenshot shows the 'Update Encryption Key File' section with an 'UPDATE' button. Below it are fields for 'MAC Address' (00:0B:AA:06:00:0A) and 'Adaptor Name' (000BAA06000A). The 'Adaptor Language' dropdown menu is set to 'English'. The 'Video Setting' section has 'Frame Rate' and 'Quality' dropdown menus open, showing options: 1fps, 5fps, 10fps, and 15fps. Below the menus are 'CANC' and 'SAVE' buttons, and a 'Reboot' button at the bottom left.

**MEMO**

- Raising the Frame Rate from 1 fps to 15 fps gives you a smoother image quality. Also, raising the Quality from 1 to 10 gives you a finer image. However if both the Frame Rate and Quality are raised at the same time, a large amount of network bandwidth will be required.

## Saving the settings

Save the changed settings.

1. Click [SAVE].
  - "[Network] Setting has been saved." is displayed, and the Reboot Confirmation dialog is displayed.

The screenshot shows the 'Adaptor Language' dropdown menu set to 'English'. Below it are 'Video Setting' fields for 'Frame Rate' (15fps) and 'Quality' (10(High)). The 'SAVE' button is highlighted with a red box. Other buttons include 'CANCEL', 'Reboot', and 'Update Encryption Key File'.

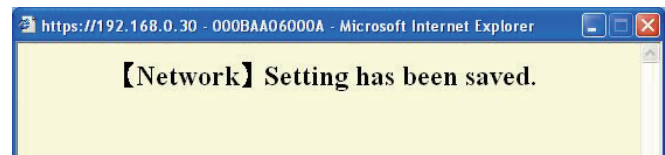

**MEMO**

- Setting operations are canceled if you click [CANCEL], and you are returned to the Administrator Settings window.

### 3-3-6 Log Downloading / Firmware Update

#### Log Downloading (for Inspections and Maintenance)

For maintenance and inspection, you can acquire the operations log from the IP Video Intercom Adaptor.

- MEMO**
- If you are logged in as a User, you cannot perform a Log Downloading/Firmware Update.
  - The IP Video Intercom Adaptor records the most recent 10 days worth of operations logs. When the recording capacity is exceeded, the logs are overwritten, starting from the log with the oldest recording date.

1. Click the [Setting] button of "Log/Firmware Update" from the Administrator Settings window.

- The Log/Firmware Update window is displayed.

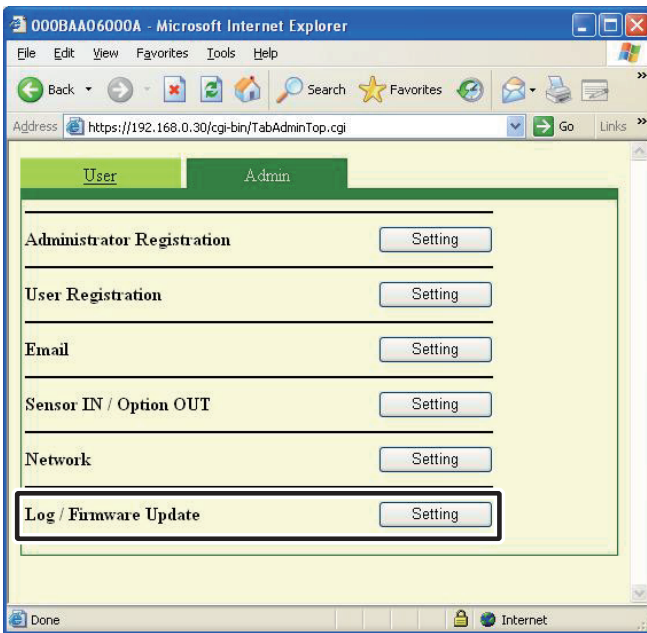

2. Click [Download] from "Adaptor Log".

- The Log File Download dialog is displayed.

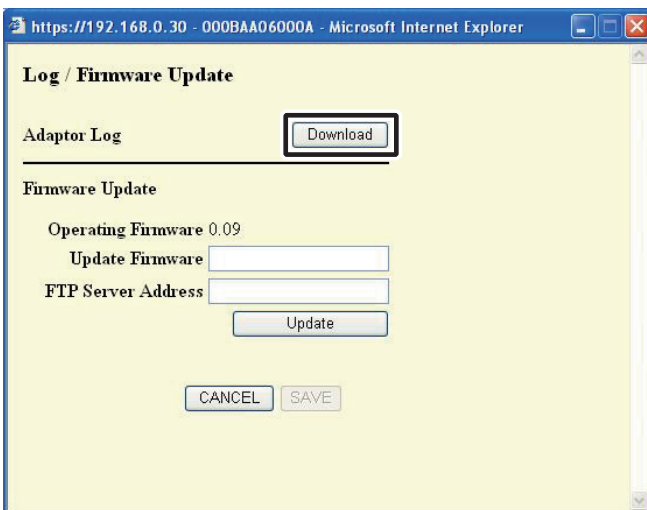

- MEMO**
- Downloading is canceled if you click [CANCEL], and you are returned to the Administrator Settings window.

3. Click [Save].

- The Save As dialog is displayed and you can give the file a name.

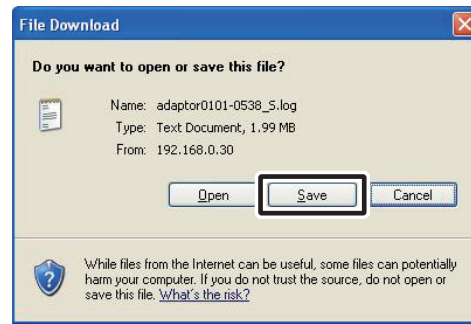

4. Select the target directory, and then click [Save].

- You are returned to the Log/Firmware Update window.

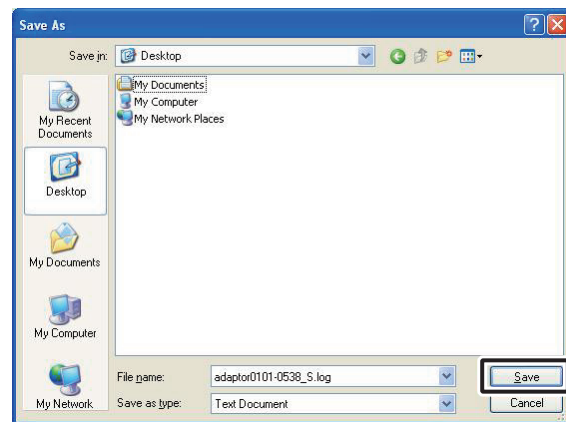

#### Operations Log Example

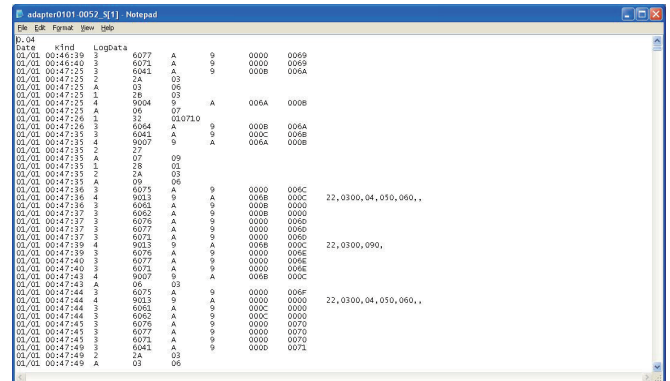

- The IP Video Intercom Adaptor may not operate correctly during log downloading.

## Firmware Update

To update the IP Video Intercom Adaptor firmware, you need to set the PC as a server beforehand and then save the firmware to be updated on the server.

You may also need to turn off the Windows Firewall and security software functions.

### Setting up an FTP Server

Select "Add or Remove Programs" from the computer's "Control Panel", and then click "Add/Remove Windows Components". Select "Internet Information Services (IIS)", and then click "Details".

Select "File Transfer Protocol (FTP) Service", and then click "OK".

On the following page, click "Next".

FTP Server setup is complete.

 The Internet Information Services are not available for Windows XP Home Edition. Please check our homepage at <http://www.aiphone.net>.

### Downloading Updated Firmware Data

Please access our homepage at <http://www.aiphone.net/> and download the firmware data.

For the download procedure, see the instructions on our homepage.

Save the downloaded data in the folder "C:\inetpub\ftproot" (factory default setting status) of the computer which has been set up as the FTP server.

**1.** Click the [Setting] button of "Log/Firmware Update" from the Administrator Settings window.

• The Log/Firmware Update window is displayed.

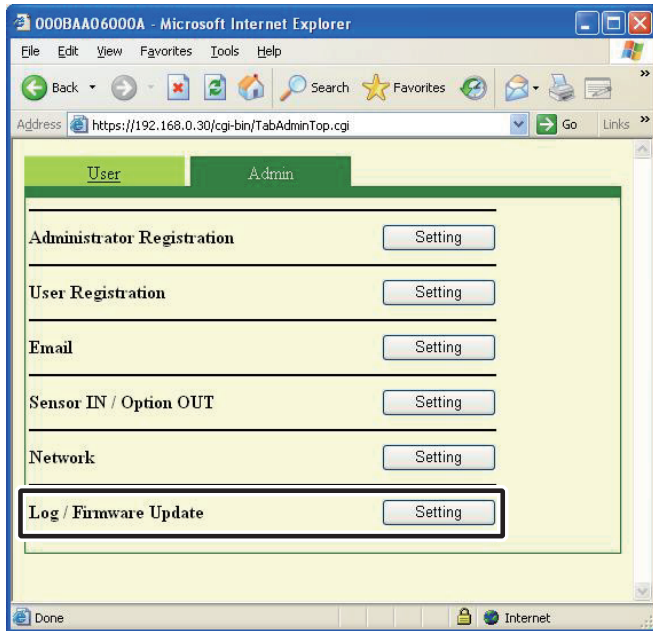

**2.** Enter a version for Update Firmware and FTP Server Address, and then click [Update].

• The Update Confirmation dialog is displayed.

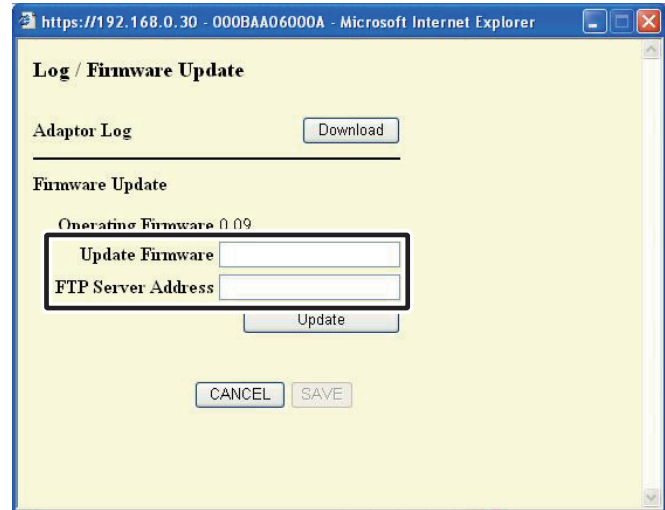

### MEMO

- When entering the Update Firmware, please omit the periods ".". For example: If the version is "1.01", enter "101"
- For the FTP Server Address, enter the name of the server where the update file is saved. Normally, this is the IP Address of the user's computer.

**3.** Click [OK].

• The update file is downloaded from the FTP server. It takes several seconds to download.

• The Update window is displayed, and the update begins.

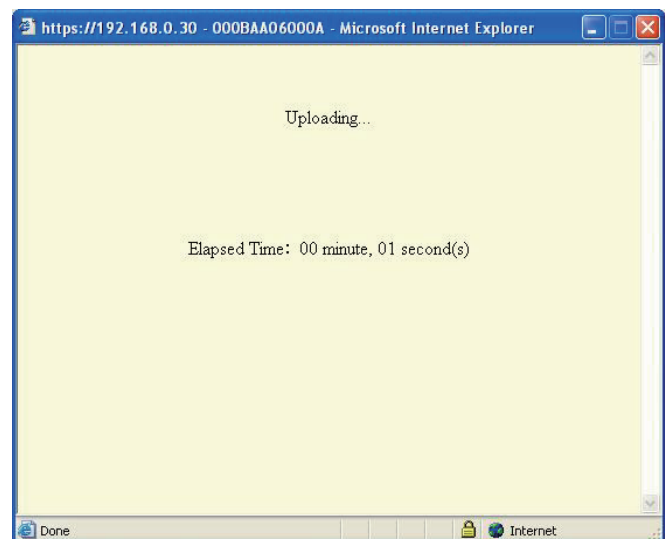

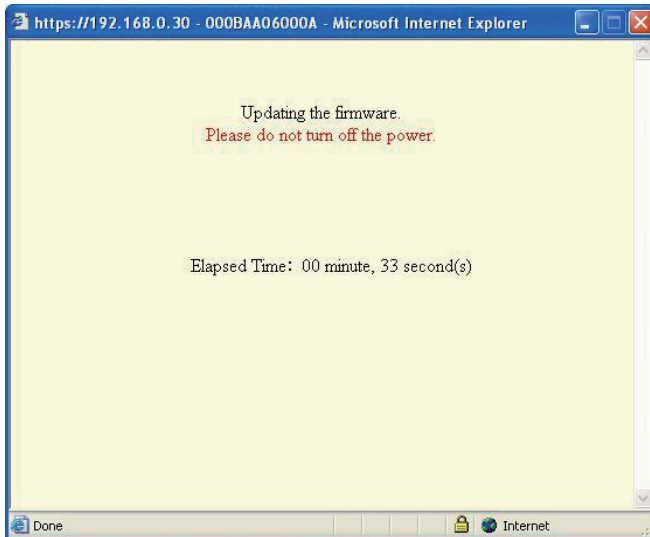

- The downloaded update file is written to the circuit board. Writing takes about 2 minutes.
- "Firmware update was completed successfully." is displayed, and the update process is complete.

**MEMO** • Do not turn off the power while the firmware is being written. If the power is turned off while it is writing, the product will malfunction.

#### 4. Click [Reboot].

- [System is initializing. Please wait. Elapsed Time XX seconds.] is displayed, and the IP Video Intercom Adaptor is rebooted. It takes about 100 seconds to reboot.
- When the reboot is complete, the Administrator Settings window is displayed.

**MEMO** • If the update fails, the [Return] button is displayed. Click [Return] and go back to **2**.

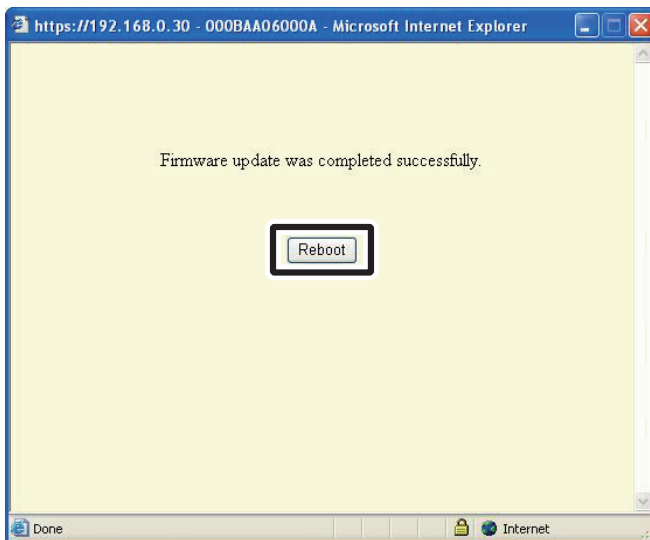

**MEMO** • Depending on the computer and the OS environment, the screen displays may differ.

**⚠** The corresponding IP Video Intercom Adaptor does not operate during firmware updating.

## 3-4 User Settings

User Settings for the PC Application can be made from the User Settings window while logged in as the Administrator or a User.

### 3-4-1 Downloading Encryption Key

To use the Door release and Option Output with the PC Application, you need to obtain the Encryption Key Files from each IP Video Intercom Adaptor beforehand and set them for the respective IP Video Intercom Adaptors with the PC Application.

Also, when the Administrator updates the Encryption Key, it needs to be reacquired and installed again.

### Downloading and Setting the Encryption Key File

1. After starting up the PC Application, select an optional "Adaptor", and then login as the Administrator or a User.
  - The User Settings window is displayed.

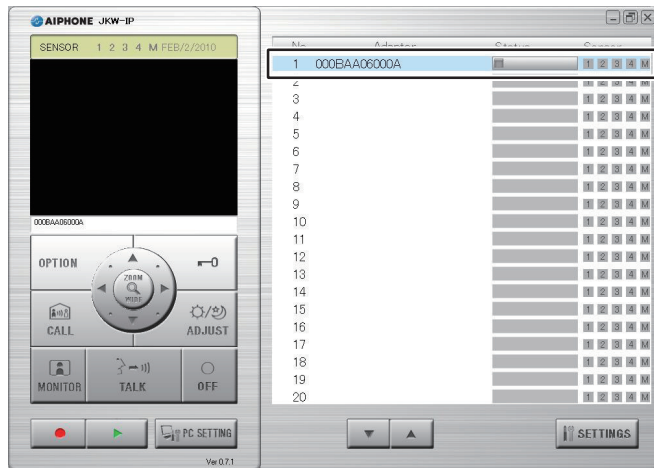

**MEMO** • See "Logging in" for more details on logging in. **P.20**

2. Click [Download] of [Download Encryption Key] from the User Settings window.
  - The Download Encryption Key screen is displayed.
  - The MAC Address for the IP Video Intercom Adaptor is displayed as the Encryption Key File name.

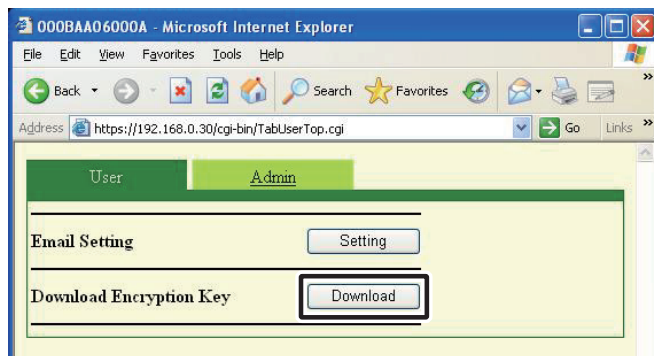

3. Click [Save].

- The Save As dialog screen is displayed and you can give the file a name.

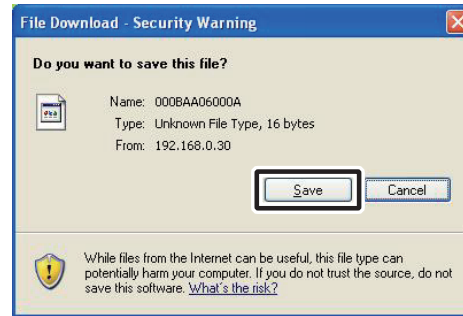

4. Select the target directory, and then click [Save].

- The Encryption Key File is saved, and you are returned to the User Settings window.

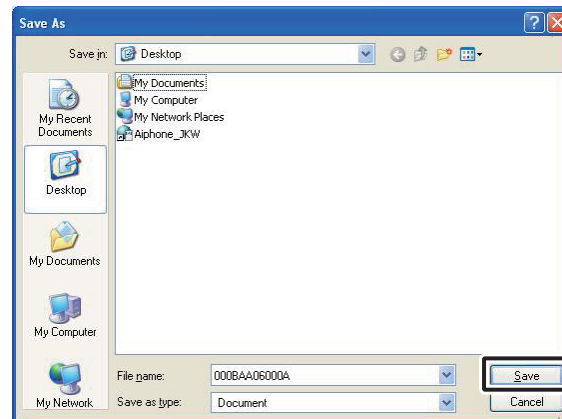

5. From the Expanded Window, after selecting an "Adaptor" from the list, right-click and select "Encryption Key" from the menu displayed.

- The Encryption Key File Setting window is displayed.

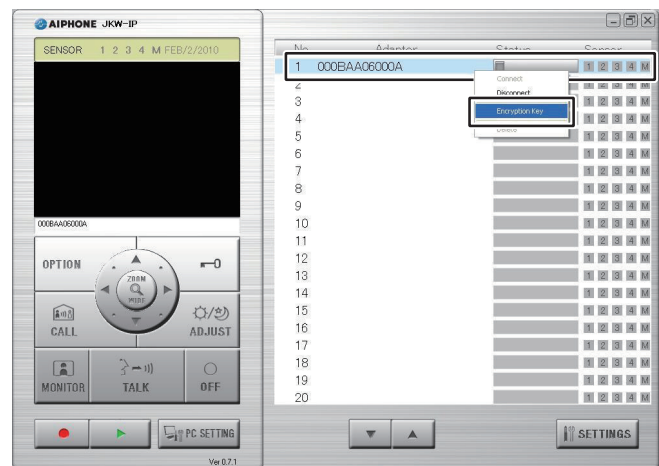



- Select the Encryption Key File corresponding to the selected "Adaptor".

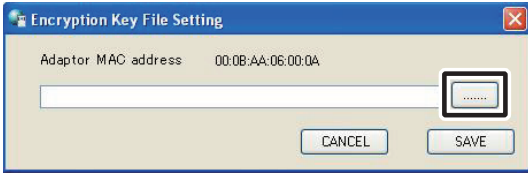

- Click [SAVE].
  - The Encryption Key is set, and you are returned to the Expanded Window.

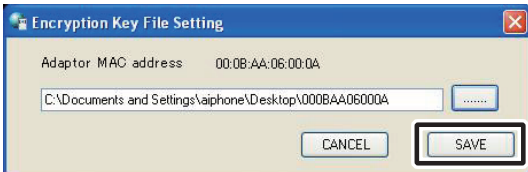

**MEMO** • Setting operations are canceled if you click [CANCEL], and you are returned to the Expanded Window.

- When the Encryption Key setup is complete, the icon in the [Status] column changes from gray to blue.

- Carry out 1. to 7. for all IP Video Intercom Adaptors connected to the system.

**MEMO**

- If the Encryption Key does not match between the IP Video Intercom Adaptor and the PC Application, you cannot operate Door release or Options.
- Once the Encryption Key is set, the Status display is lit blue, even if the Encryption Key is not matched.
- Never change or delete the Encryption Key File folder after the Key is set. The Encryption Key will not match.
- When the Encryption Key is updated, set it again. See "Update Encryption Key File" **P.27** in Administrator Settings for details on updating the Encryption Key File.

### 3-4-2 Email Setting

Various User Settings for the PC Application can be made from the User Settings window while logged in as the Administrator or a User.

**MEMO** • You cannot change settings for multiple IP Video Intercom Adaptors at the same time. Make various settings for each IP Video Intercom Adaptor.

Use the following method to display the User Settings window.

- After starting up the PC Application, select an optional "Adaptor", and then login as the Administrator or a User.
  - The User Settings window is displayed.

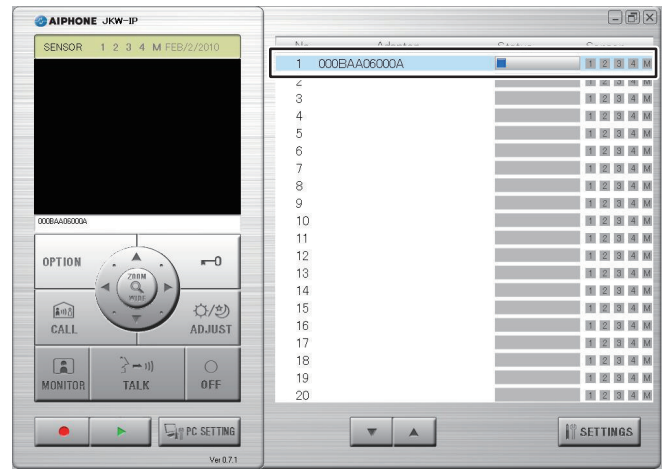

**MEMO** • See "Logging in" for more details on logging in. **P.20**

- Click [Setting] of [Email Setting] from the User Settings window.

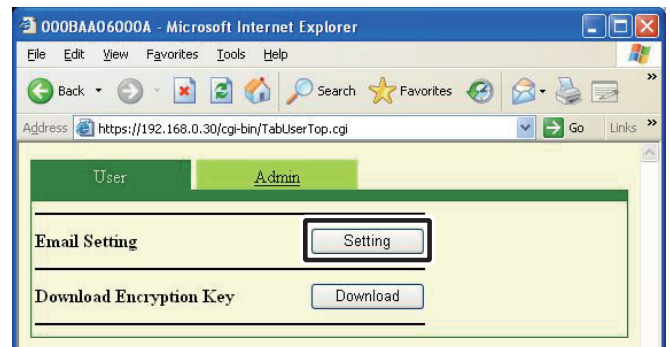

### Setting the Target Email Address and the Email Timing

Register the Email Address of the receiver to which a notification is to be sent when a Door Call, Sensor Detection, or System Start is detected.

In the Email Timing settings, you can set whether or not Email is transmitted when Door Call, Sensor Detection, or System Start is detected.

- When Door Call is set to "ON", the snapshot displayed on the monitor at the time of the call is attached to the Email and sent. No Email is sent from the second call.
- When Sensor Detection is set to "ON", Email is sent when the sensor detection is activated.

**MEMO** • To send Emails from the IP Video Intercom Adaptor, the Administrator needs to make the [Email Setting] beforehand.

#### Setting the target Email Address

1. Enter an Email address in the "Email Address" field in the Email Setting window.

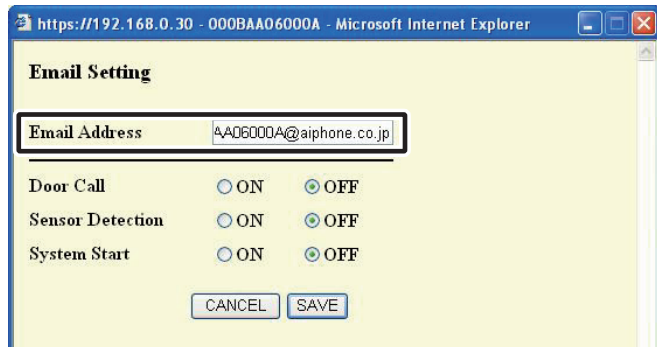

#### Email Timing Settings

2. Select the check box for the timing setting from the Email Setting window.

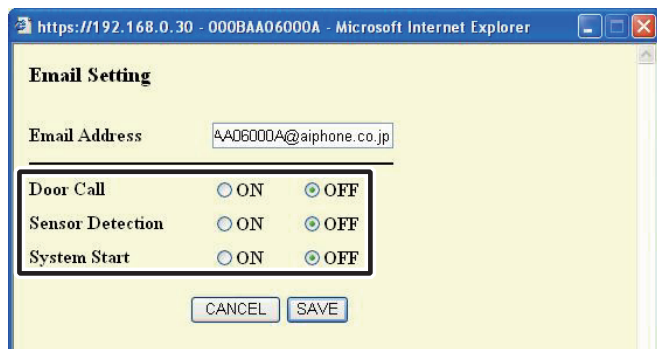

3. Click [SAVE].

- "[Email Setting] Setting has been saved." is displayed, the entered Email Address is set, and you are returned to the User Settings window.

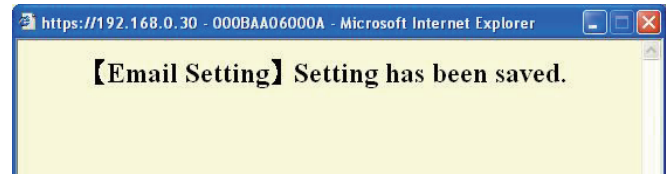
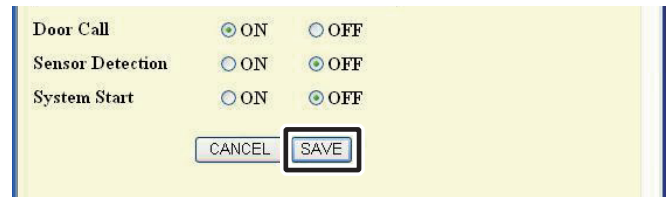

**MEMO** • Setting operations are canceled if you click [CANCEL], and you are returned to the User Settings window.  
 • All settings are returned to their factory default settings if you press the IP Video Intercom Adaptor default setting switch for 5 seconds or more.

# 4 PC Application Settings

## 4-1 Setting the PC Application

Registration : Administrator/User

Various settings for the PC Application can be made from the PC Application Settings window.

Use the following method to display the PC Application Settings window.

### 1. Starting up the PC Application

- The Expanded Window is displayed.

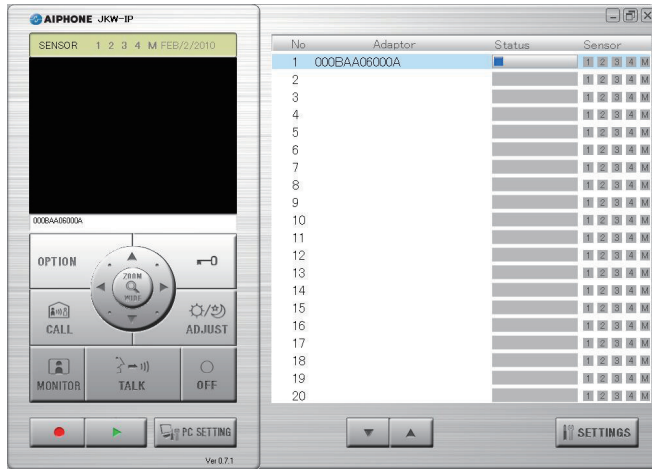

### 2. Click [PC SETTING].

- The PC Application Settings window is displayed.

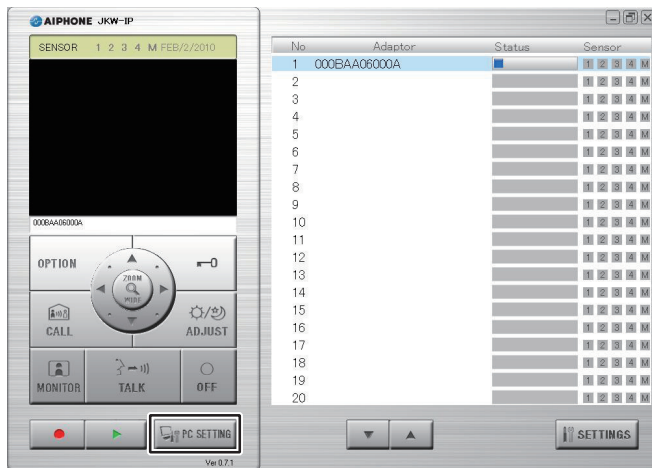

### 4-1-1 Volume Settings

To adjust the volume, click the "Volume" tab from the PC Application Settings window to display the settings screen. The following 3 settings come under Volume Settings.

- Microphone Volume
- Speaker Volume
- Tone Volume

#### <<Note: Volume Adjustment>>

- When talking, if you cannot hear audio from the door station or the master monitor station even after turning up the Speaker Volume, try turning down the Microphone Volume little by little. (Because it uses a hands-free (VOX) system, if the Microphone Volume is too high, it might not switch to the receiver's side.)
- The Microphone Volume settings and the Speaker Volume settings are synchronized with the computer's settings. Please note that the communication volume is changed when you change the volume in "Sounds and Audio Devices Properties" from the computer.
- Depending on the computer's environment, the sound quality may be bad or communication may not be possible.

**CAUTION** Do not adjust the volume with your ear close to the speaker. A sudden increase in volume could damage your eardrum.

1. Move each Volume slider left or right to set the optimum volume, and select a sound device for the Tone Volume.

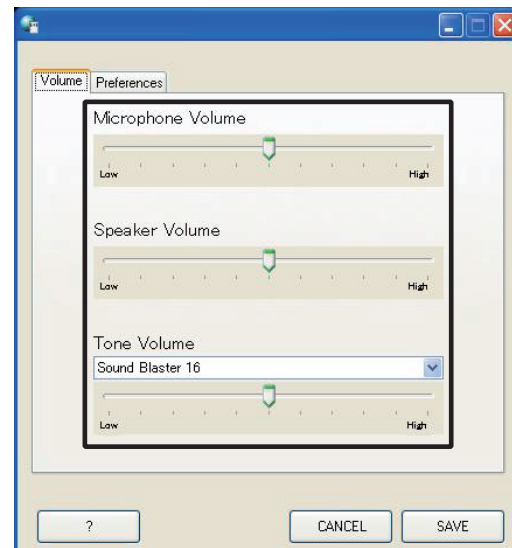

- The Tone Volume is linked to the Call Tone and Sensor Detection Tone.

**2.** Click [SAVE].

• The Volumes are set and the PC Application Settings window closes.

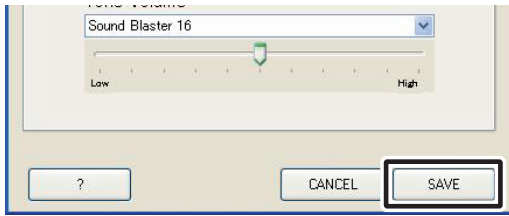

- MEMO**
- Setting operations are canceled if you click [CANCEL], and the PC Application Settings window closes.
  - The Microphone Volume and Speaker Volume settings are synchronized with the computer's settings. For more information, see the Operation Manual supplied with your computer.
  - Click [ ? ] to display a help pop-up window.

**4-1-2 Preferences Settings**

To adjust the Preferences Settings, click the "Preferences" tab from the PC Applications Settings window to display the settings screen.

The following 6 settings come under Preferences settings.

- Language Selection Settings
- Event Notification Settings
- Picture Recording Mode Settings
- Max. Recording Space Settings
- Auto Recording Settings
- Audio Recording Settings

**Language Selection Settings**

You can select the screen display language from "English", "French", "Spanish", "German", "Dutch", "Italian", and "Japanese". The default setting is "English".

1. Click the drop-down menu button for "Language Selection", and then select the language.

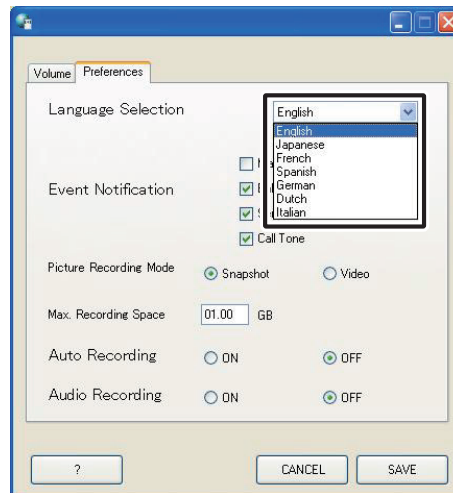

- MEMO**
- To apply the selected language, you need to restart the PC Application.

**Event Notification Settings**

You can set Maximize Application (screen display), Balloon Notification, Sensor Detection Tone, and Call Tone to either ON or OFF. The default settings are - Maximize Application (screen display) only: "OFF", the other settings are all "ON".

1. Select Event Notification and change the settings.

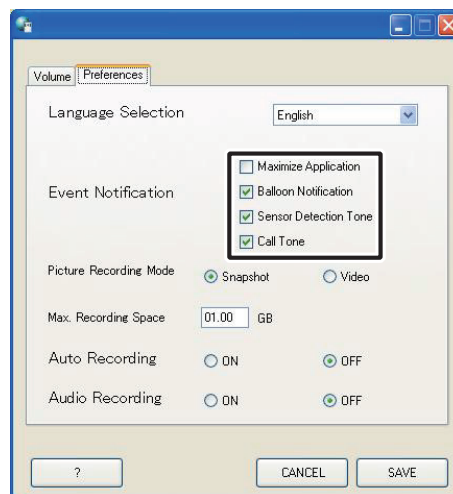

### Event Notification Operation List

Setting	Description	Reference
Maximize Application	When there is a call from (one of) the door station(s), or when Sensor Detection occurs (even when minimized), the PC Application is automatically maximized.	
Balloon Notification	When there is a call from (one of) the door station(s), or when Sensor Detection occurs, a Balloon Notification appears.	P.45
Sensor Detection Tone	When a sensor connected to the IP Video Intercom Adaptor or master monitor station operates, the Sensor Detection Tone sounds.	P.45
Call Tone	When there is a call from the door station, etc., the Call Tone sounds.	P.39 P.42

### Picture Recording Mode Settings

You can choose the image recording method from "Snapshot" which only records one image from the door station, or "Video" which continuously records images from the door station. The default setting is [Snapshot].

1. Click [Snapshot] or [Video] in Picture Recording Mode.

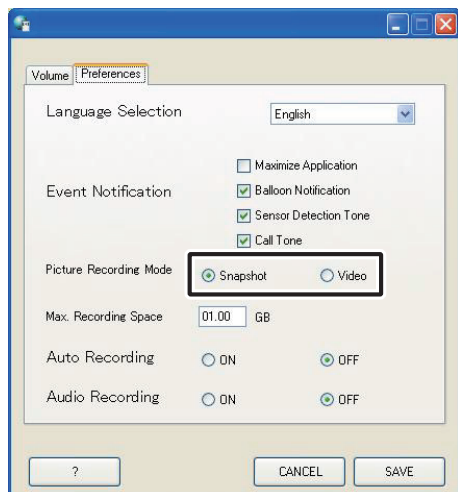

### Max. Recording Space Settings

You can set the Max. Recording Space for images to between "00.01" and "10.00" GB. The default setting is "01.00".

1. Enter a value between "00.01" and "10.00" as the Max. Recording Space.

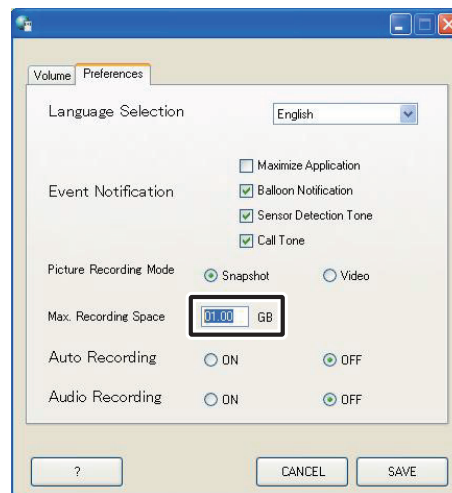

**MEMO**

- You cannot record more than will fit in the free space on the computer.
- You cannot record more than will fit in the set Max. Recording Space. (Do not overwrite)

### Auto Recording Settings

You can select whether or not to automatically record images of the door station when a call is received from the door station. The default setting is "OFF".

1. Click [ON] or [OFF] in Auto Recording.

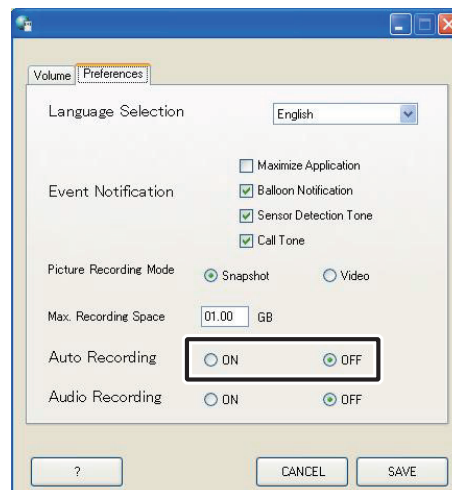

**MEMO**

- You cannot make audio recordings when [Snapshot] is set.
- When [Video] is set, and the [Audio Recording Settings] P.38 is set to ON, manual video recording and audio recording are performed simultaneously. You cannot make audio recordings when Auto Recording is set.

### Snapshot Recording and Video Recording Operation List

		Description
Snapshot	Auto recording	When there is a call from the door station, only one snapshot image of the entrance is recorded. A snapshot is also recorded for the second call.
	Manual recording	During calls from the door station, when monitoring the door station, and when talking with the door station, you can manually record only one entrance image using snapshot.
Video	Auto recording	When there is a call from the door station, the video recording of the entrance starts. If there is a call from another door station during video recording, the recording is stopped. Video recording stops when a call from the door station is answered. Video recording stops when the call from the door station ends, and you are returned to the standby screen.
	Manual recording	During calls from the door station, when monitoring the door station, and when talking with the door station, you can make video recordings of the entrance manually. When communication starts during the video recording of monitoring, you can continue the recording. When the communication or the monitoring ends, video recording stops. When [Audio Recording Settings] P.38 is set to ON, audio recording can also be performed when manual video recording is performed, during monitoring of the door station, and when talking with the door station.

## Audio Recording Settings

You can select whether or not to make an audio recording during manual video recording. The default setting is "OFF" (No audio recording performed).

**1.** Click [ON] or [OFF] in Audio Recording.

- When performing Audio Recording, be sure to set Picture Recording Mode to [Video]. You cannot make audio recordings when [Snapshot] is set.

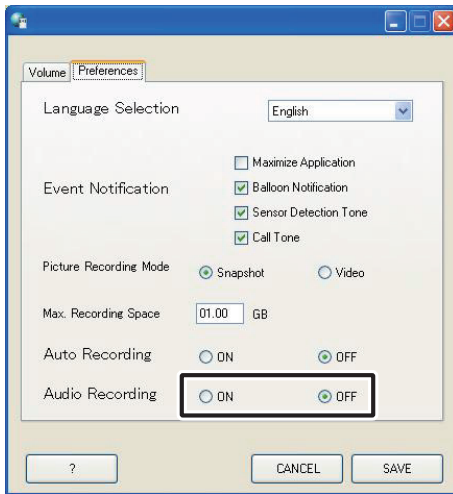

**MEMO** • Even if Audio Recording is ON, recording will not start during auto video recording or when the machine is in calling mode (before beginning to talk).

## Saving the settings

Save the changed settings.

**1.** Click [SAVE].

- The settings are saved and the PC Application closes.
- If an Event Notification was changed, the Event Notification is set and the PC Application Settings window closes.

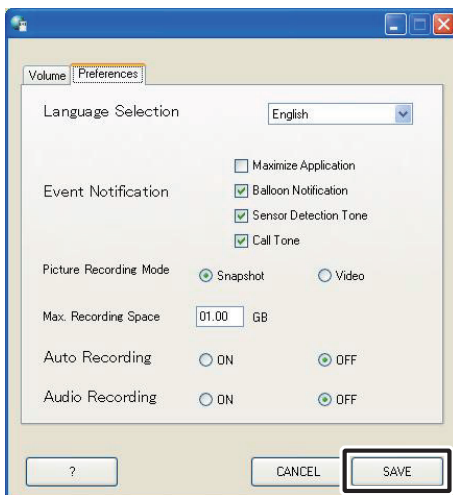

# 5 PC Application Basic Operations

## 5-1 Video Intercom Functions

By using the PC Application, you can operate the following video intercom functions for the video intercom system and synchronized devices (electronic door lock and other connected devices, etc.) connected to the IP Video Intercom Adaptor.

Controllable Video Intercom Functions	Reference
Answering a call from the door station	P.39
Door release	P.40
Zoom/Wide, Pan & Tilt	P.41
Adjust image	P.42
Room-to-room communication (Communication with a master monitor station)	P.42
Entrance monitoring	P.44
Sensor Detection from Connected Equipment	P.45
Option Output from IP Video Intercom Adaptor	P.45
Balloon Notification	P.45

- The keyboard shortcut keys can be used to operate the PC Application.  
[OFF]: [Esc], [TALK]: [Space]

### 5-1-1 Answering a call from the door station

- When there is a call from the door station, a call tone sounds and the entranceway image is displayed on the PC Application screen.

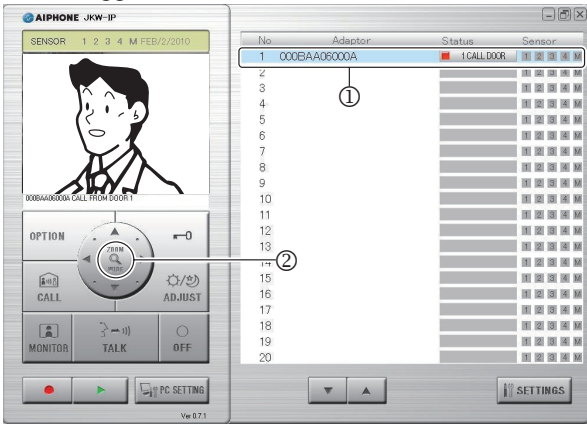

Status:	(Red) 1 CALL DOOR (Numbers indicate the order of the calls)
MESSAGE:	<Adaptor Name> CALL FROM DOOR <Door station No.>

- The corresponding "Adaptor" (the IP Video Intercom Adaptor connected to the calling door station) enters Selected status (①).
- In this status, you can switch the image display to Zoom screen/Wide screen by clicking the [ZOOM / WIDE] (②). For more information, see "Zoom/Wide, Pan & Tilt". P.41
- The screen is switched when "Zoom/Wide" or "Pan & Tilt" is operated from a master monitor station or another PC Application.
- When the call timer's set time (about 45 seconds) has elapsed, the PC Application returns to standby status. The PC Application also returns to standby status when the master monitor station answers a call from the door station.
- The communication time depends on the master monitor station settings.
- The Instant voice call function is not available in the PC Application.
- If the check mark is removed from Call Tone in "Event Notification Settings" P.36, the call tone will not sound.

⚠ The screen for image acquisition is displayed until the image is displayed on the PC Application screen.

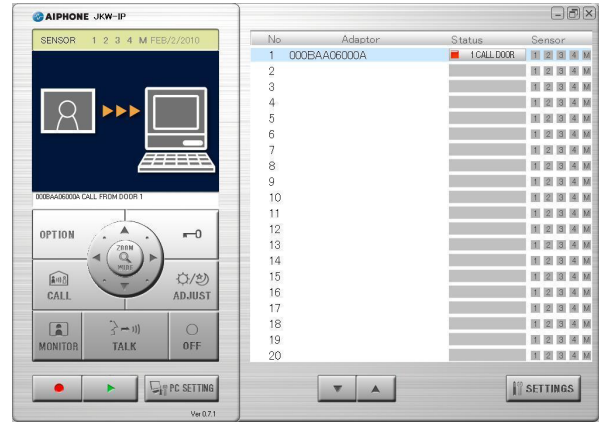

When the system is composed of multiple IP Video Intercom Adaptors, master monitor stations, door stations, and PCs.

All PC Applications are called when there is a call from any of the door stations in the system.

**MEMO**

- When a master monitor station is communicating with the PC Application, and a call comes in from the door station of the master monitor station, only the PC Application currently active is called.
- When calling multiple PC Applications, the displayed image may be slowed down.
- When calling multiple PC Applications, the image displayed on the PC Application may be delayed, depending on the number of connections.

When the following processes occur one after another, "1 CALL DOOR" and "COMMUNICATION" are displayed alternately in the "Status" display section of the Expanded Window (③).

- When there is a call from the door station of the master monitor station while talking with the master monitor station.

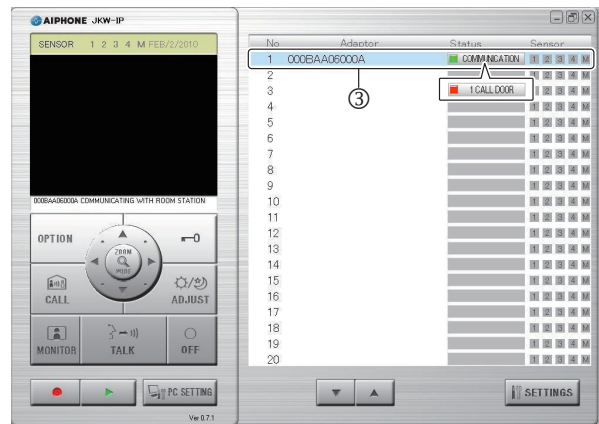

- When you click "OFF", the image from the calling door station is displayed, and you can click [TALK] to start the communication.

**MEMO**

- Even if the master monitor station does not have a recording function, you can record using the PC Application.

**2.** Click [TALK] (①), for a call from the door station.

- You can click [TALK] (①) to communicate, even if the screen for image acquisition is displayed.

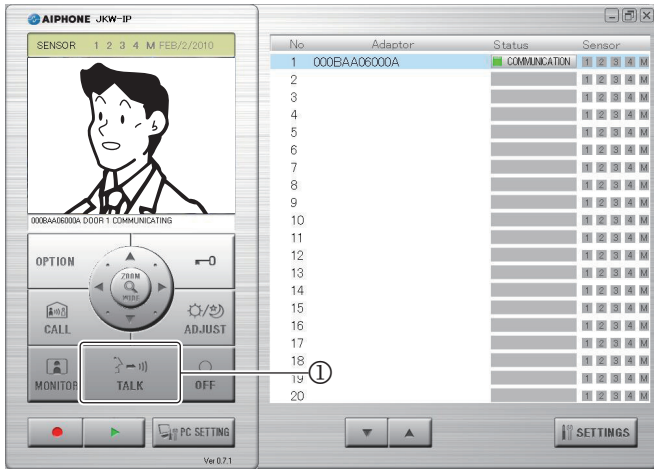

Status:	(Green) COMMUNICATION
MESSAGE:	<Adaptor Name> DOOR <Door station No.> COMMUNICATING

- You can communicate with the door station.
- Press-to-Talk  
When you click and hold [TALK] for over one second, you can communicate in the press-to-talk mode. To talk with the caller, press and hold [TALK]. To listen to the caller, release [TALK].  
\* If the caller speaks loudly, you may hear their voice even while pressing and holding [TALK].

**3.** When the communication is complete, click [OFF] (②).

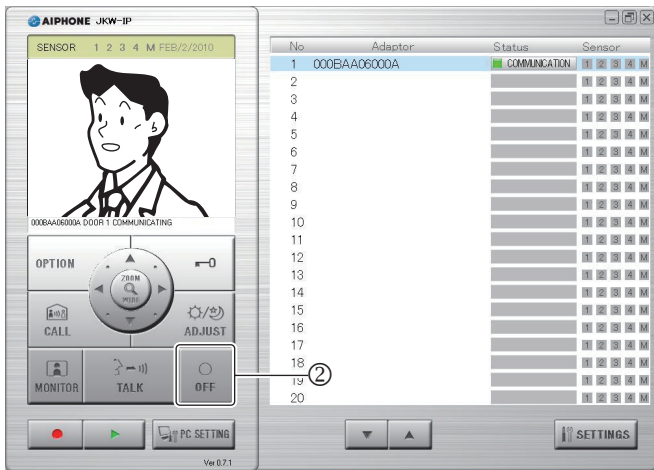

- The PC Application returns to standby status.

**5-1-2 Door release**

While being called from the door station, talking or monitoring, you can unlock the door from the PC Application by clicking [ ] (Door release) on the PC Application.

**1.** Click [ ] (Door release).

- The door is unlocked while the button is clicked and held.
- When unlocked, [ ] (Door release) turns red.
- \* Depending on the communication delay, the timing of the button turning red and the actual door release may differ.

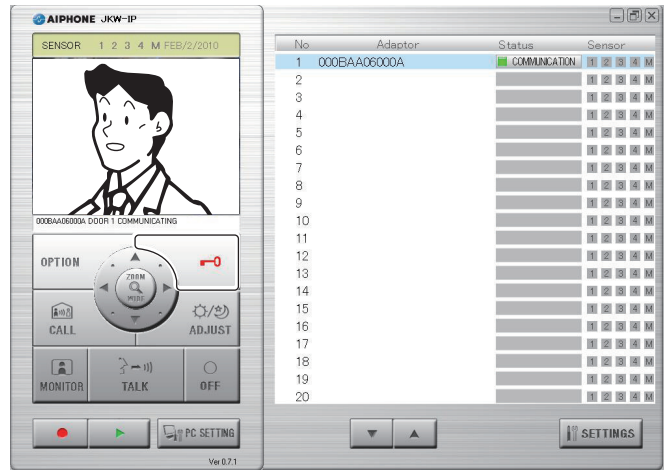

**MEMO** • To perform door release, you need to set the Encryption Key.



### 5-1-3 Zoom/Wide, Pan & Tilt

By using the following steps, the monitor screen of the PC Application can be switched between a wide picture and a zoom picture.

- Calling from the door station
- Entrance monitoring
- Communicating with the door station

By using Pan & Tilt when a zoom picture is displayed, a wide picture can be split into 9 images and displayed as 1 picture.

**MEMO** • If the door station is operated from another PC Application or a master monitor station at the same time as Zoom/Wide or Pan & Tilt, the operation may not be enabled, due to communication overlap and control processing.

#### Zoom/Wide switching

1. Click [ZOOM / WIDE] (①) when the image is displayed on the PC Application screen.

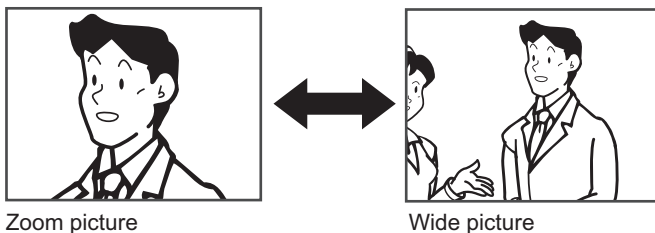
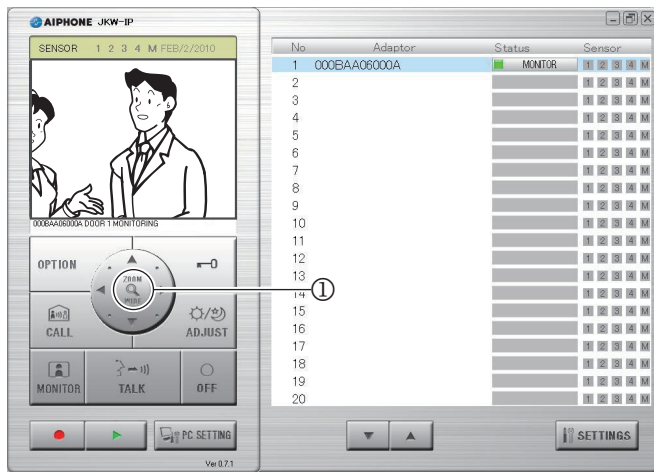

- The screen switches between the zoom picture and the wide picture each time you click [ZOOM / WIDE].

**MEMO** • If visitors are not displayed in the center of the screen during Zoom, click [Pan & tilt], and then move the screen.  
 • When the screen switches from a wide picture to a zoom picture, the image from the position preset by the master monitor station is displayed.

⚠ Depending on the properties of the door station camera, the wide screen may appear more distorted than the zoom screen, but this is not a malfunction.

#### Pan & Tilt operation

1. Click the [Pan & tilt] (②) ▲▼◀▶ buttons while a zoom picture is displayed.

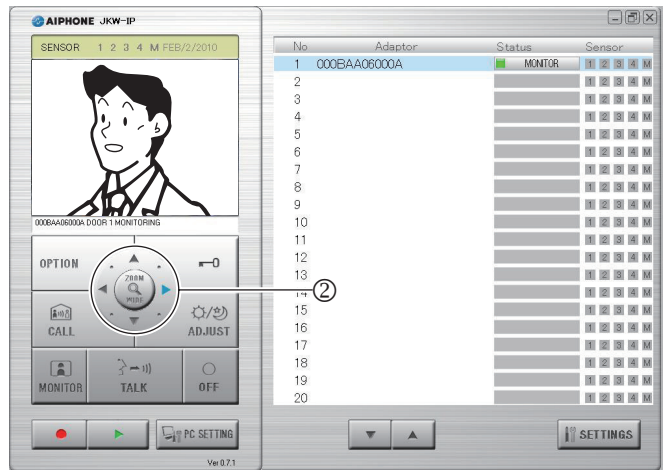

- The target image is displayed.
- You can move the image diagonally by clicking the [Pan & tilt] diagonal buttons.

#### Moving the image with the [Pan & tilt] button



### 5-1-4 Adjust image

If the image displayed on the PC Application screen is difficult to see, you can adjust the image using [ADJUST] (①).

You can adjust the backlight during the day when a bright background makes it difficult to see.

You can make it brighter at night when it is darker.

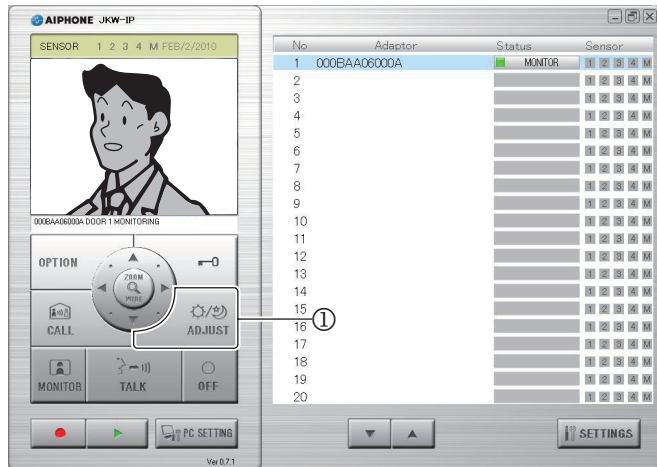

• If you click [ADJUST] again while the image is being adjusted, the image is returned to the status from before adjustments were made.

#### Backlight adjustment, Night sensitivity adjustment image

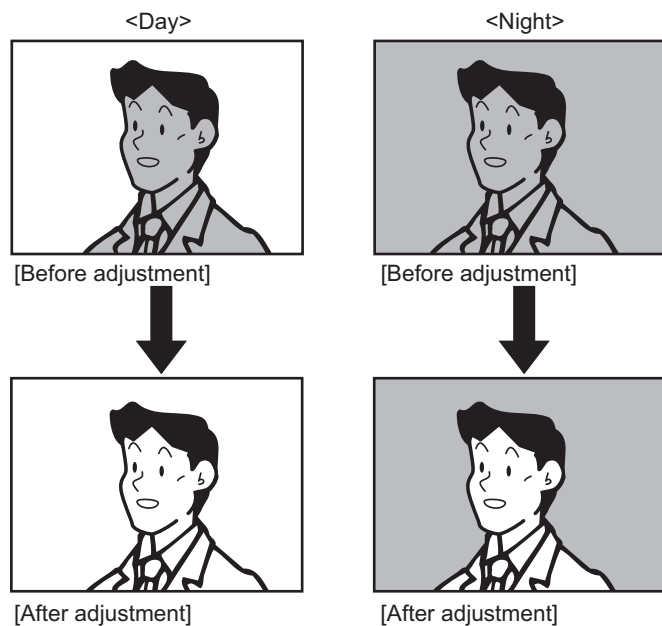

**MEMO**

- If the door station is operated from another PC Application at the same time as Adjust image, the operation may not be enabled, due to communication overlap and control processing.
- Clicking [ADJUST] (①) at night may make visitors' faces easier to see, but may also make moving objects more difficult to see.
- The discrimination between day and night is performed automatically by the door station.

### 5-1-5 Room-to-room communication (Communication with a master monitor station)

Mutual calls and communication are possible between the PC Application and the master monitor station.

#### Receiving a call from / communicating with the master monitor station

1. A call tone sounds when there is a call from the master monitor station, and a message is displayed in the PC Application's [MESSAGE] display (①).
  - All PC Applications are called when there is a call from any of the master monitor stations in the system.
  - \*If the check mark is removed from Call Tone in "Event Notification Settings" P.36, the call tone will not sound.
  - When the master monitor station ends room-to-room communication, the PC Application returns to standby status (this includes call timeouts).

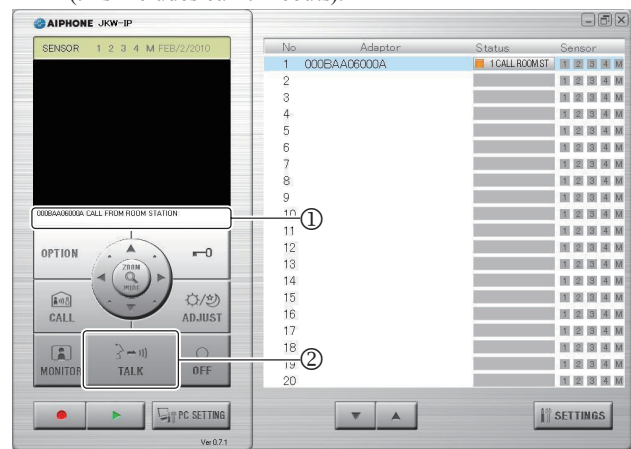

Status:	■ (Orange) 1 CALL ROOM ST (Numbers indicate the order of the calls)
MESSAGE:	<Adaptor Name> CALL FROM ROOM STATION

2. When this happens, click [TALK] (②).
  - You can then talk to the master monitor station.
  - Press-to-Talk  
When you click and hold [TALK] for over one second, you can communicate in the press-to-talk mode. To talk with the caller, press and hold [TALK]. To listen to the caller, release [TALK].
  - \* If the caller speaks loudly, you may hear their voice even while pressing and holding [TALK].
3. To end the communication, click [OFF] (③).

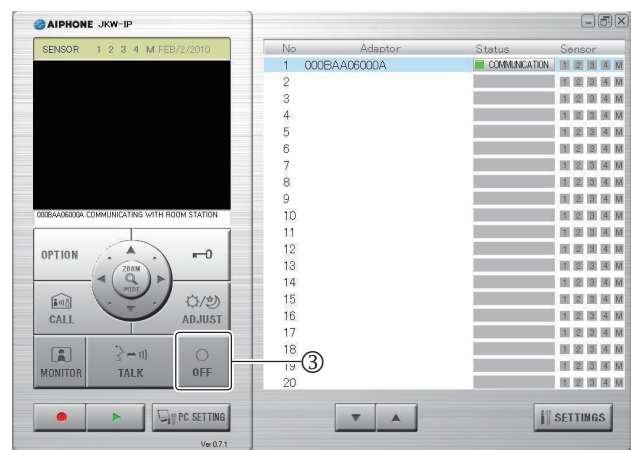

• The PC Application returns to standby status.

### Calling / communicating with the master monitor station

If you want to call a master monitor station from the PC Application, you can choose to call all master monitor stations in the system, or call one specific master monitor station.

1. From the "Adaptor" display (①) in the Expanded Window, select the master monitor station-connected IP Video Intercom Adaptor you want to call.

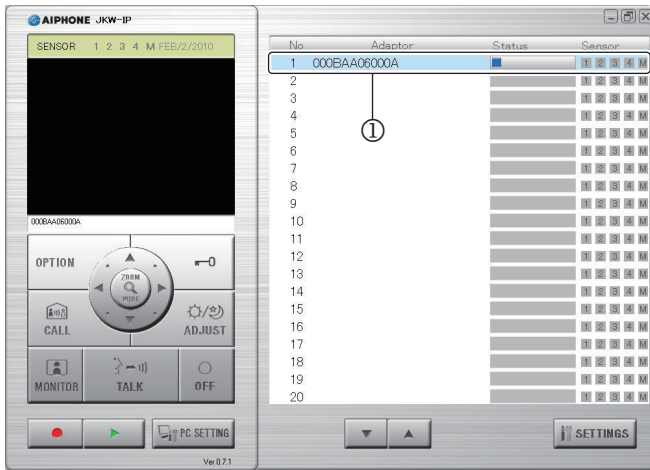

- When calling all master monitor stations in the system, do not select any Adaptors. If an Adaptor is selected, you can release it by clicking it again.

**MEMO** • You cannot select specific multiple Adaptors. You can select "One Adaptor" or "All Adaptors".

2. Click [CALL] (②).

- You can choose to call the master monitor station connected to the IP Video Intercom Adaptor that you selected, or call all master monitor stations.

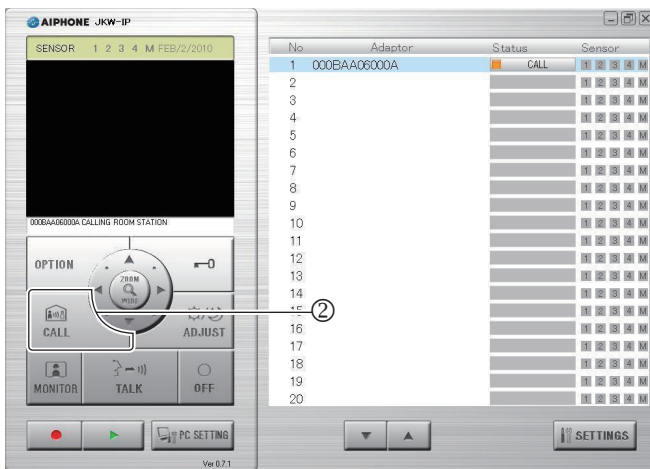

Status :	(Orange) CALL
MESSAGE :	<Adaptor Name> CALLING ROOM STATION

- When you call all the master monitor stations, "CALLING ROOM STATION" is displayed.

3. You can communicate when a master monitor station starts the communication.

- Press-to-Talk

When you click and hold [TALK] for over one second, you can communicate in the press-to-talk mode. To talk with the caller, press and hold [TALK]. To listen to the caller, release [TALK].

\* If the caller speaks loudly, you may hear their voice even while pressing and holding [TALK].

- When you are calling all the master monitor stations, communicate with the master monitor station which starts the communication first. The other master monitor stations enter standby mode.

4. To end the communication, click [OFF] (③).

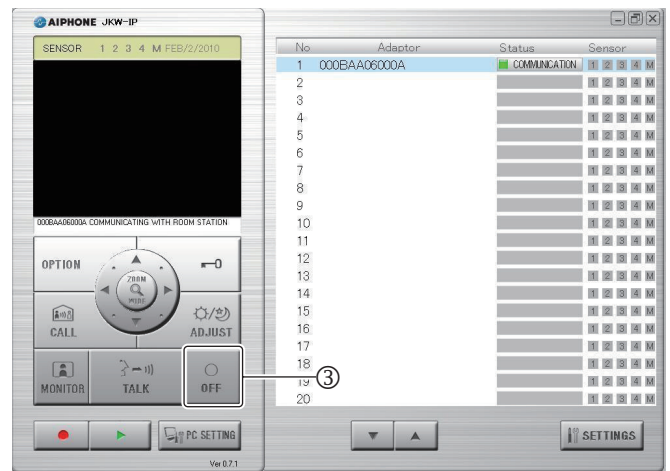

- The PC Application returns to standby status.
- The master monitor station cannot perform an OFF operation to finish calls from the PC Application.

### 5-1-6 Entrance monitoring

You can monitor a door station from the PC Application.

1. From the "Adaptor" display (①) in the Expanded Window, select one door station-connected IP Video Intercom Adaptor you want to monitor.

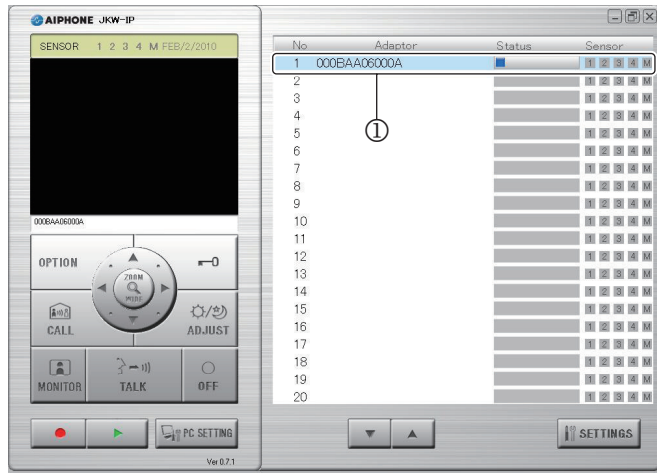

- If an Adaptor is selected, you can release it by clicking it again.

**MEMO** • You can only select one Adaptor to monitor the door station.

2. Click [MONITOR] (②).

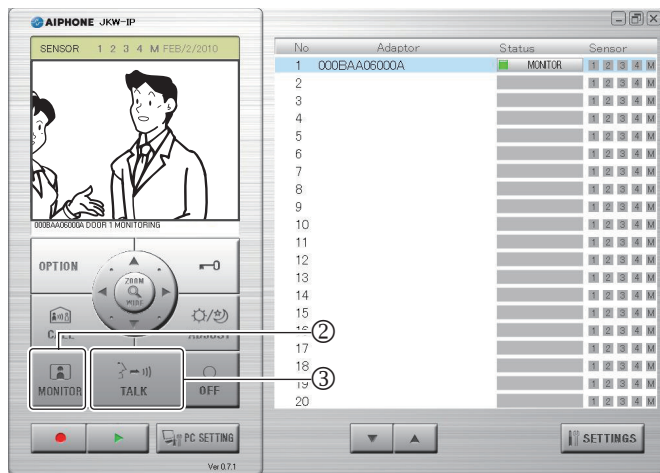

Status :	<span style="color: green;">■</span> (Green) MONITOR
MESSAGE :	<Adaptor Name> DOOR <Door station No.> MONITORING

- The image from the door station connected to the selected Adaptor is displayed, and audio is received.
- While monitoring, click [TALK] (③) to begin talking. At night, the door station's LED for night illumination lights.
- The discrimination between day and night is performed automatically by the door station.

**MEMO**

- The entrance monitoring turns off automatically after approximately 1 minute. To monitor the entrance again, repeat from 1.
- During entrance monitoring, the entrance monitoring time can be extended by approximately 1 minute by clicking [MONITOR] again.
- During entrance monitoring, the screen is set to the wide screen display. It switches to the zoom screen when the [ZOOM / WIDE] button is clicked.
- At night, the door station's LED for night illumination does not light until [TALK] (③) is clicked.

3. To finish monitoring, click [OFF] (④).

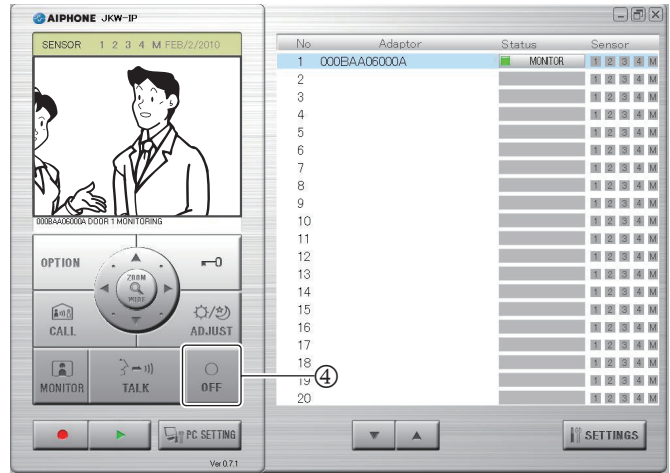

- The PC Application returns to standby status.
- When the monitor display time has elapsed, the monitoring is automatically switched off, and it returns to standby status.

### 5-1-7 Sensor Detection from Connected Equipment

You will be notified by the PC Application if sensors connected to the master monitor station and IP Video Intercom Adaptor are activated.

1. If a sensor detects an abnormality, or the connected call button etc. is pressed, the Sensor Detection Tone occurs.

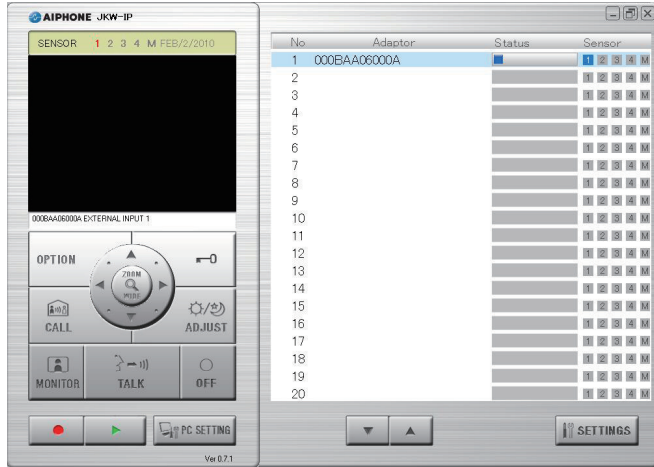

Sensor:	1、2、3、4、M (Blue)
MESSAGE:	<Adaptor Name> EXTERNAL INPUT or <Adaptor Name> EXTERNAL INPUT <No.>

2. Click [OFF].
  - The Sensor Detection Tone stops and the sensor indicator turns off.
  - The Sensor Detection Tone can also be stopped in the following situations.

#### Sensor Detection Tone Recovery

External (Sensor) input	Description
IP Video Intercom Adaptor external input	If the input latch setting is "30 sec.", then it automatically stops after 30 seconds.
Master monitor station external input	Stopped by the master monitor station. If the input latch setting is "30 sec.", then it automatically stops after 30 seconds. <sup>*1</sup>

\*1 However if the notification tone sounding time is set to "Continuous" in the sensor input settings of the master monitor station, the sensor indicator remains on until recovery.

**MEMO** • For the sensor input settings, refer to "Sensor Input Settings" on **P.24**.

- If the check mark is removed from Sensor Detection Tone in "Event Notification Settings" **P.36**, the Sensor Detection Tone will not occur.
- If sensors are activated during communication, the Sensor Detection Tone will not occur.

### 5-1-8 Option Output from IP Video Intercom Adaptor

You can operate equipment connected to the IP Video Intercom Adaptor from the PC Application.

1. Click [OPTION].

**MEMO** • The [OPTION] button turns green while being operated.  
• To perform option output operations, you need to set the Encryption Key.

\*Depending on the communication delay, the timing of the button turning green and the actual control timing may differ.

### 5-1-9 Balloon Notification

When an event occurs, a balloon notification is displayed on the PC screen.

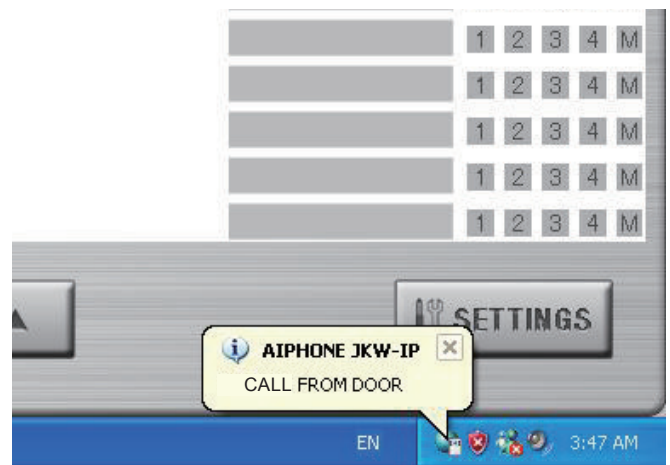

#### Balloon Notification Content

Notification	Event Content
CALL FROM DOOR	Indicates a call from a door station.
CALL FROM ROOM ST	Indicates a call from a master monitor station.
EXTERNAL INPUT	Indicates external input detection.
CANNOT RECORD. SPACE IS FULL.	Displayed when there is not enough free space on the hard disk drive.

**MEMO** • If there is not enough free space on the hard disk drive during a door call, the message "CANNOT RECORD. SPACE IS FULL." is displayed.  
• The balloon notification disappears automatically when the computer is operated. The balloon notification also disappears if you click it while it is displayed.  
• See "Event Notification Settings" for Balloon Notification settings. **P.36**  
• "CANNOT RECORD. SPACE IS FULL." is displayed even when balloon notification is set to off.

## 5-2 Recording Function

The PC Application can record images from the video intercom system connected to the IP Video Intercom Adaptor automatically or manually.

### 5-2-1 Auto Recording

When a call is received from the door station, the entranceway images are recorded automatically.

If there is a call from another door station during communication, the image displayed on the PC Application is automatically recorded after the communication ends.

When communication with the door station starts, Auto Recording stops. Auto Recording also stops when the call from the door station ends, and you are returned to the standby screen.

See "Auto Recording Settings" for more information on automatic recording. [P.37](#)

**MEMO** • When Auto Recording is set and the call from the door station ends, recording stops.

### Snapshot recording when Auto Recording is set

One snapshot image of the entrance is recorded when the following condition is met.

- When the call button at the door station is pressed

See "Picture Recording Mode Settings" for more information on snapshot images. [P.37](#)

**MEMO** • A snapshot can also be recorded for the second call from the door station.  
 • If there is a call from a door station during communication, a snapshot of the image displayed on the PC Application is automatically recorded after the communication ends.

### Video recording when Auto Recording is set

A video recording of the entrance is made when the following condition is met.

- When the call button at the door station is pressed

See "Picture Recording Mode Settings" for more information on video recording settings. [P.37](#)

1. Once the above operation has been performed, video recording starts for the image displayed on the PC Application screen.

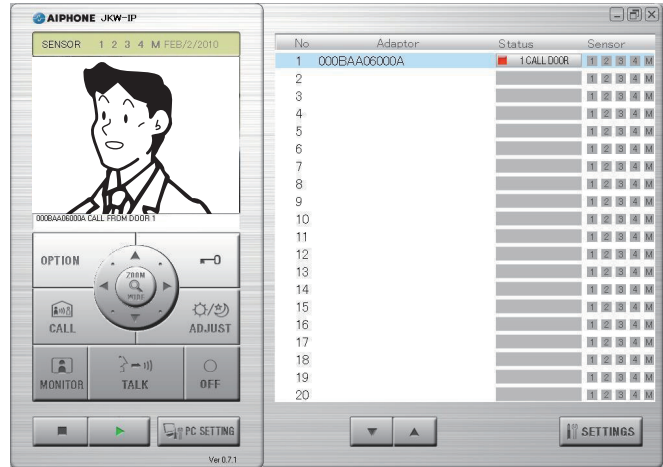

- If there is a call from another door station during video recording, video recording is stopped.

2. If you want to stop video recording, click [■(Stop)] (①).

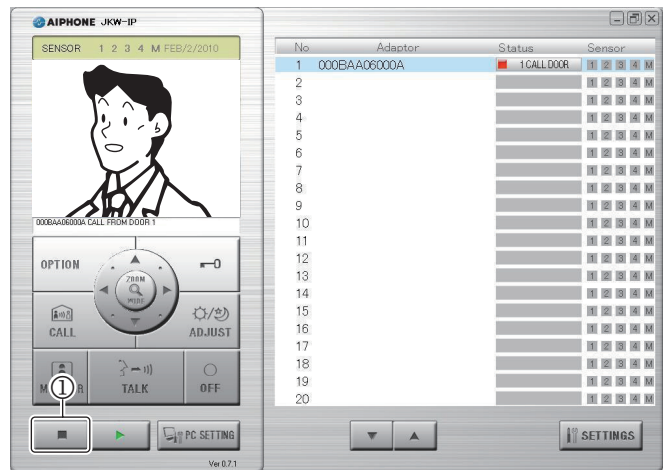

- Video recording stops when a call from the door station is answered.
- Video recording stops when the call ends, and you are returned to the standby screen.

## 5-2-2 Manual recording

You can make a snapshot recording or video recording of the entrance when the following conditions are met.

- Calling from the door station
- Entrance monitoring
- Communicating with the door station

### Snapshot recording

You can only record one snapshot image of the entrance manually when the following conditions are met.

- Calling from the door station
- Entrance monitoring
- Communicating with the door station

See "Picture Recording Mode Settings" for more information on snapshot recording. [P.37](#)

1. Click [●(Rec)] (①), while communicating with the door station.

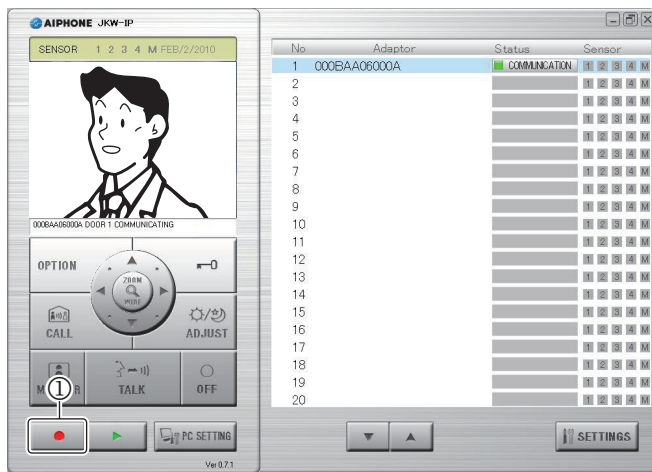

- Only one snapshot of the image displayed on the PC Application screen is recorded.

### Video recording

You can make a video recording of the entrance manually when the following conditions are met.

- Calling from the door station
- Entrance monitoring
- Communicating with the door station

When communication starts during the video recording of monitoring, you can continue recording.

When the communication or monitoring ends, video recording stops.

See "Picture Recording Mode Settings" for more information on video recording settings. [P.37](#)

If Audio Recording is set, you can make video and audio recordings simultaneously when the following conditions are met.

- Entrance monitoring
- Communicating with the door station

See "Audio Recording Settings" for more information on audio recording settings. [P.38](#)

1. Click [●(Rec)] (①), while communicating with the door station.

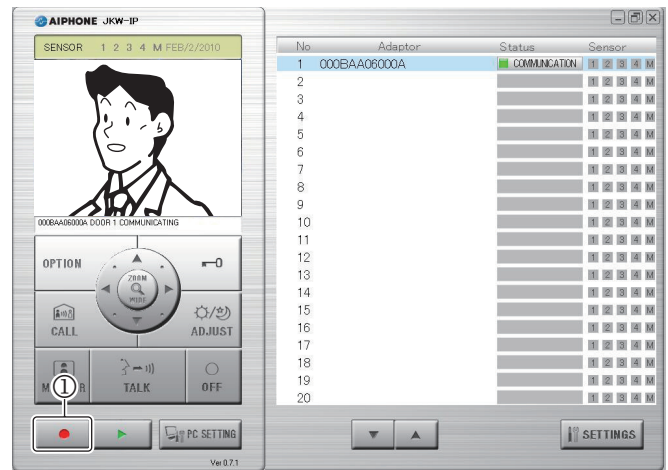

- Starts video recording the image displayed on the PC Application screen.
- If you are video recording while receiving a call from a door station, and there is a call from another door station, video recording is stopped.

**MEMO** • When you click [TALK] while recording the monitoring, recording continues until the set Communication time has elapsed or until [OFF] is clicked.

2. To stop video recording, click [■(Stop)] (②).

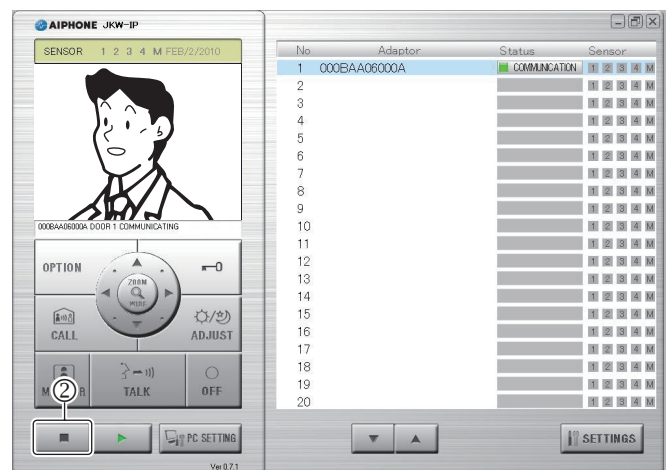

- When the door station's monitoring time has elapsed, video recording is stopped.
- Video recording stops when communication with the door station ends.

## 5-3 Playback Function

In the PC Application, you can play back, stop, pause, slow down the playback, and fast forward the recorded images. You can delete any unnecessary recorded files.

### 5-3-1 Play recorded image

1. Click [▶(Open play window)] (①) in the Standard Window.

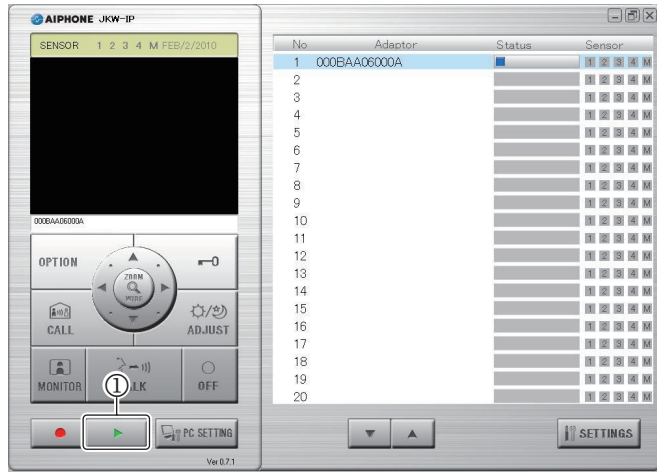

- The recorded file list is displayed.

2. Enter the target IP Video Intercom Adaptor and the recording period (Start Date/End Date).

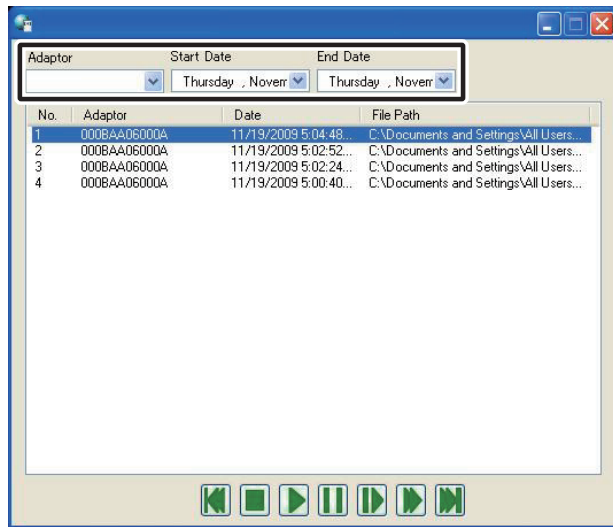









- A list of recorded files corresponding to the search conditions is displayed.
- Dates in the recorded file list are displayed in reverse chronological order.
- You can display the data in the recorded file list in order of Adaptor name or date by clicking either "Adaptor" or "Date".
- The name entered under Network Settings in Administrator Settings is displayed as the Adaptor.

3. Select a recorded file.

4. Select a playback operation.

- The snapshot or video is displayed on the PC Application screen. If audio has been recorded for the video, the audio is also played back.
- If you click another recorded file during playback, playback of the recorded file stops.
- If a call is received from a door station or another room station during playback, playback of the recorded file stops.

#### Playback Operations List

Button Name	Description
 (Play)	<p>The selected recorded file is played back at normal speed.</p> <ul style="list-style-type: none"> <li>• When playback reaches the end of the recorded file, the file directly below the recorded file is automatically played back.</li> <li>• When playback ends for the final recorded file in the list, the last frame of the last file is displayed as a paused screen.</li> <li>• Under normal playback conditions, one snapshot recorded image is usually displayed for 2 seconds.</li> <li>• If you click  during fast forward or slow playback, it returns to normal playback speed.</li> </ul>
 (Stop)	<p>Stops playback of recorded files.</p> <ul style="list-style-type: none"> <li>• When the playback of a recorded file is stopped, no image is displayed on the screen.</li> </ul>
 (Pause)	<p>Pauses the recorded file currently being played back.</p> <ul style="list-style-type: none"> <li>• While paused, clicking  again moves the recorded images along one frame at a time.</li> <li>• When the playback of the final frame of a recorded file is paused, and you click  again, the first frame of the recorded file directly below the current file is displayed.</li> </ul>
 (Slow)	<p>The recorded file is played back at about one quarter of the normal speed.</p>
 (Fast Forward)	<p>The recorded file is played back at about four times the normal speed.</p>
 (Prior File)	<ul style="list-style-type: none"> <li>• During normal playback Replays the recorded file currently being played back from the beginning.</li> <li>• During Stop The recorded file one line above the currently selected file is selected.</li> <li>• During Pause The first frame of the recorded file currently being paused is displayed. If the first frame of the recorded file is paused, then the first frame of the recorded file directly above the current file is displayed.</li> <li>• During Slow Replays the recorded file currently being played back in slow motion from the beginning.</li> <li>• During Fast Forward Replays the recorded file currently being played back in fast forward from the beginning.</li> </ul>

Continued on the next page



Button Name	Description
 (Next File)	<ul style="list-style-type: none"> <li>• During normal playback The recorded file directly below the file currently being played is played back.</li> <li>• During Stop The recorded file one line below the currently selected file is selected.</li> <li>• During Pause The first frame in the recorded file directly below the file currently being paused is displayed. If the first frame of the recorded file is paused, then the first frame of the recorded file directly below the current file is displayed.</li> <li>• During Slow The recorded file directly below the file currently playing is played back in slow motion from the beginning.</li> <li>• During Fast Forward The recorded file directly below the file currently playing is played back in fast forward from the beginning.</li> </ul>

### 5-3-2 Deleting a Recorded File

You can delete any unnecessary recorded files.

1. Open Aiphone\_JKW\_Rec.
  - If you selected a different directory during installation, please open the selected directory.
  - For details on the storage location of recorded files, see [P.14](#).

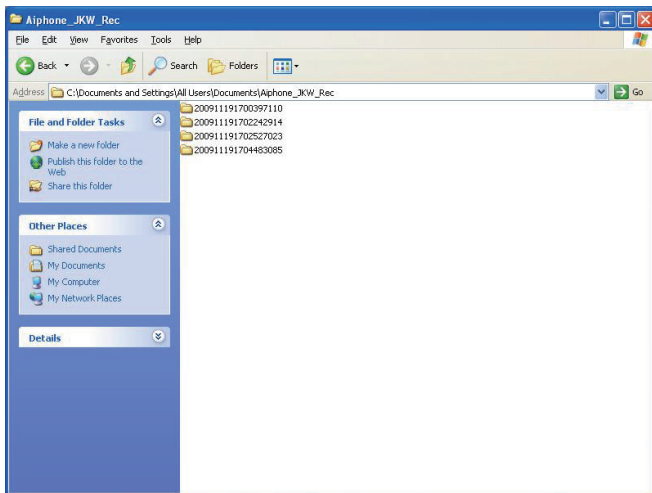

- The folder name is the date of recording.

3. Select a recorded file.
4. Right-click and select Delete.
  - The recorded file is deleted.

## 5-4 Sending Email

You can have Emails sent to the computer, PDA, or cell phone whenever a door call, sensor detection, or system start up occurs.

**!** To send Email from the IP Video Intercom Adaptor, you first need to setup a valid Email address and Email server.

See "Email Setting (IP Video Intercom Adaptor)" in Administrator Settings [P.23](#) and "Email Setting" in User Settings [P.33](#) for more information on Email settings.

### Content of transmitted Email

Timing	Title	Text
When there is a call from the door station	<Adaptor Name>	<Adaptor Name> CALLING FROM DOOR <Door station No.>
When the master monitor station detects External (Sensor) input	<Adaptor Name>	<Adaptor Name> EXTERNAL INPUT
When JKW-IP detects External (Sensor) input	<Adaptor Name>	<Adaptor Name> EXTERNAL INPUT <No.>
When the system starts up	<Adaptor Name>	<Adaptor Name> SYSTEM START

**MEMO**

- The mail title and text cannot be changed.
- The above-mentioned events which have occurred in the previous 60 seconds are summarized and sent in the Email.
- A snapshot (QVGA JPEG) is attached to an Email when a door call occurs.

# 6 Others

## Settings List

Setting Contents		Setting Range	Default	Setting Authority	Saved Settings Location
Administrator Registration	Administrator ID	Up to 16 single-byte alphanumeric characters	aiphone	Administrator	JKW-IP
	Administrator Password	Up to 16 single-byte alphanumeric characters	aiphone	Administrator	JKW-IP
User Registration	User ID	Up to 16 single-byte alphanumeric characters	—	Administrator	JKW-IP
	User Password	Up to 16 single-byte alphanumeric characters	—	Administrator	JKW-IP
Network Settings (IP Video Intercom Adaptor)	Adaptor Name	Up to 24 single-byte alphanumeric characters and symbols* <sup>1</sup>	MAC Address	Administrator	JKW-IP
	Connection	Manually or by DHCP	Manually	Administrator	JKW-IP
	IP Address	Each field 0 to 255 (decimal)	192.168.0.30	Administrator	JKW-IP
	Subnet Mask	Each field 0 to 255 (decimal)	255.255.255.0	Administrator	JKW-IP
	Default Gateway	Each field 0 to 255 (decimal)	192.168.0.30	Administrator	JKW-IP
	Primary DNS	Each field 0 to 255 (decimal)	—	Administrator	JKW-IP
	Secondary DNS	Each field 0 to 255 (decimal)	—	Administrator	JKW-IP
	MAC Address	—	—	—	JKW-IP
	Web Port	1-65535	443	Administrator	JKW-IP
	Connection Port	1-65535	5060	Administrator	JKW-IP
	Connection Password	Up to 8 single-byte alphanumeric characters	aiphone	Administrator	JKW-IP
	Audio Port	1-65535	65002	Administrator	JKW-IP
	Video Port	1-65535	65202	Administrator	JKW-IP
	Update Encryption Key File	—	—	Administrator	JKW-IP
Email Setting	Adaptor Email Address	Up to 180 single-byte alphanumeric characters and symbols* <sup>2</sup>	—	Administrator	JKW-IP
	SMTP Server	Up to 64 single-byte alphanumeric characters and symbols* <sup>3</sup>	—	Administrator	JKW-IP
	(Email) login ID	Up to 180 single-byte alphanumeric characters and symbols* <sup>2</sup>	—	Administrator	JKW-IP
	SMTP Password	Up to 64 single-byte alphanumeric characters	—	Administrator	JKW-IP
	SMTP Server Port	1-65535	465	Administrator	JKW-IP
	SSL	ON or OFF	OFF	Administrator	JKW-IP
Adaptor Language Settings (IP Video Intercom Adaptor)	Adaptor Language	English, French, Spanish, German, Dutch, Italian, Japanese	English	Administrator	JKW-IP
Video Setting	Resolution	—	QVGA (320x240)	Administrator	JKW-IP
	Frame Rate	1, 5, 10, 15 fps	15 fps	Administrator	JKW-IP
	Quality	1 (Low) to 10 (High)	10	Administrator	JKW-IP
Sensor input Settings	Sensor input	N.C. or N.O.	N.O.	Administrator	JKW-IP
	Input latch duration	30 seconds or continuous	Continuous	Administrator	JKW-IP
Option output Settings	Option output	—	N.O.	Administrator	JKW-IP
	Output Duration	0 to 600 seconds, Output when clicked if 0 is set.	3 seconds	Administrator	JKW-IP
Language Selection Settings (PC Application)	PC Application Language Selection Settings	English, French, Spanish, German, Dutch, Italian, Japanese	English	User	PC
Event Notification Settings	Maximize Application	ON or OFF	OFF	User	PC
	Balloon Notification	ON or OFF	ON	User	PC
	Sensor Detection Tone	ON or OFF	ON	User	PC
	Call Tone	ON or OFF	ON	User	PC
Picture Recording Mode Settings	Picture Recording Mode	Snapshot or Video	Snapshot	User	PC
Max. Recording Space Settings	Max. Recording Space	00.01 to 10.00 GB	01.00 GB	User	PC
Auto Recording Settings	When there is a call from a door station, Auto Recording	ON or OFF	OFF	User	PC
Audio Recording Settings	When Manual & Video Recording, Audio Recording	ON or OFF	OFF	User	PC
Email (Notification) Settings	(Target) Email Address	—	—	User	JKW-IP
	Transmit Email when there is a call from the Door station	ON or OFF	OFF	User	JKW-IP
	Transmit Email when Sensor input is detected	ON or OFF	OFF	User	JKW-IP
	Transmit Email when the system is started up	ON or OFF	OFF	User	JKW-IP
Volume Settings	Microphone Volume	Synchronized with PC settings for Low to High	—	User	PC
	Speaker Volume	Synchronized with PC settings for Low to High	—	User	PC
	Tone Volume	Low to High	Medium	User	PC
	Tone Device	—	—	User	PC
Network Settings (PC Application) • PC side • WAN / Global	Connection Port	1-65535	10000	User	PC
	Audio Port	2-65534 (Even values only)	20002	User	PC
	Video Port	2-65534 (Even values only)	30002	User	PC

**\*1 Supported symbols**

! # \$ % & ' \* + - / ? ^ \_ ` { | } ~ ( ) < > [ ] ; @ .

**\*2 Supported symbols**

! # \$ % & ' \* + - / = ? ^ \_ ` { | } ~ ( ) < > [ ] : ; , @ .

**\*3 Supported symbols**

! # \$ % & ' \* + - / = ? ^ \_ ` { | } ~ .

**Operation Status Comment List**

A list of comments displayed in the PC Application.







**Operation Status Comment List**

NAMES	Display Text	Notes
Select Adaptor	<Adaptor Name>	The selected Adaptor Name is displayed.
Call from door station	<Adaptor Name> CALL FROM DOOR <Door station No.>	Adaptor Name and Door No. are displayed
Communication with a door station	<Adaptor Name> DOOR <Door station No.> COMMUNICATING	Adaptor Name and Door No. are displayed
Entrance monitoring	<Adaptor Name> DOOR <Door station No.> MONITORING	Adaptor Name and Door No. are displayed
Calling to the room stations	CALLING ROOM STATION	
Call from room station	<Adaptor Name> CALL FROM ROOM STATION	Adaptor Name is displayed
Room-to-room communication	<Adaptor Name> COMMUNICATING WITH ROOM STATION	Adaptor Name is displayed
Master Station External (Sensor) Input	<Adaptor Name> EXTERNAL INPUT	Adaptor Name is displayed
Adaptor External (Sensor) Input	<Adaptor Name> EXTERNAL INPUT <No.>	Adaptor Name is displayed
Individual calling room station	<Adaptor Name> CALLING ROOM STATION	Adaptor Name is displayed
In use	<Adaptor Name> SYSTEM IS IN USE	Adaptor Name is displayed

**"Status" list**

A "Status" list displayed in the PC Application's Expanded Window.

**"Status" list**

Color	Comment	Description
 Red	1 CALL DOOR	Displayed when there is a call from the door station Numbers indicate the order of the calls
 Green	COMMUNICATION	Displayed during communication
 Green	MONITOR	Displayed during monitoring
 Orange	1 CALL ROOM ST	Displayed when there is a call from the master monitor station Numbers indicate the order of the calls
 Orange	CALL	Displayed when there is a call from the PC Application
 Gray	<No display>	Encryption key not acquired (During standby)
 Blue	<No display>	Displayed during stand by

## Technical Precautions

- Cleaning: Clean the units with a soft cloth dampened with a neutral household cleanser. Do not use an abrasive cleanser or cloth.
- If you are experiencing difficulties with the device such as "Settings not working well", please check our homepage at <http://www.aiphone.net/>.

## Specifications

Item		Description
Power		DC18 V
Current consumption		Standby 110 mA, Maximum 200 mA
Communication		Hands-free / Press-to-talk
Image Format		JPEG
Image Resolution		320×240 (QVGA)
Network	Interface	10BASE-T/100BASE-TX Ethernet
	Protocol	TCP/IP, UDP/IP, SIP
Environment	Bandwidth	320 K to 8 Mbps (per IP Video Intercom Adaptor)
	Operating Temperature	0 ° C to 40 ° C (+32 ° F to +104 ° F)
Dimensions		200 (H)×150 (W)×35.5 (D) mm 7-7/8 (H) x 5-15/16(W) x 1-7/16 (inches)
Weight		Main Unit: Approx. 370 g (0.82 lbs)
Color		White

The PC Application is protected by intellectual property rights owned by International Systems Research Co. It is expressly forbidden to remove, use, or distribute any or all of the parts of the PC Application's component software without first obtaining the necessary license from International Systems Research Co.

# Settings Information Memo

Record your settings information. It will need when resetting or maintenance.

## IP Video Intercom Adaptor registration

Item		Setting
IP Video Intercom Adaptor	IP Address (Static)	
	Connection Port	
	Connection Password	
	Web Port	
PC Application	PC Local (LAN) IP Address	
	Connection Port	
	Audio Port	
	Video Port	
	PC Public (WAN) IP Address	
	Connection Port	
	Audio Port	
	Video Port	

## IP Video Intercom Adaptor Network Settings

Item	Setting
IP Address	
Subnet Mask	
Default Gateway	
Primary DNS	
Secondary DNS	
WAN / Global IP Address	
Connection Port	
Connection Password	
Audio Port	
Video Port	
Web Port	

## PC unit settings

Item	Setting
IP Address	
Subnet Mask	
Default Gateway	
Primary DNS (Static)	
Secondary DNS (Static)	

# Example of Registration

## For LAN / WAN

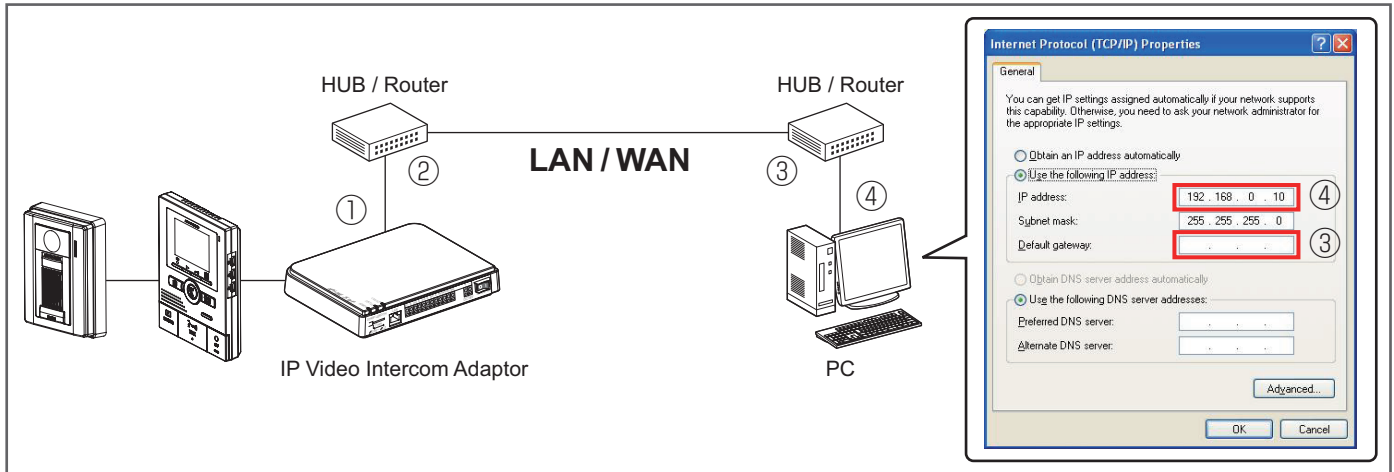

① Local IP Address and Subnet Mask that were allocated to the IP Video Intercom Adaptor

② Router local IP Address

Enter if Email will be sent

OFF

① Local IP Address that was allocated to the IP Video Intercom Adaptor

Change if necessary.

① Local IP Address that was allocated to the IP Video Intercom Adaptor

Port numbers of the IP Video Intercom Adaptor

Option Entering the ID and Password here will make it unnecessary to enter them at login.

OFF

④ Local IP Address that was allocated to the PC

Change if necessary. Set for each port type.

\*: The values shown above are the factory default settings.

**For Global**

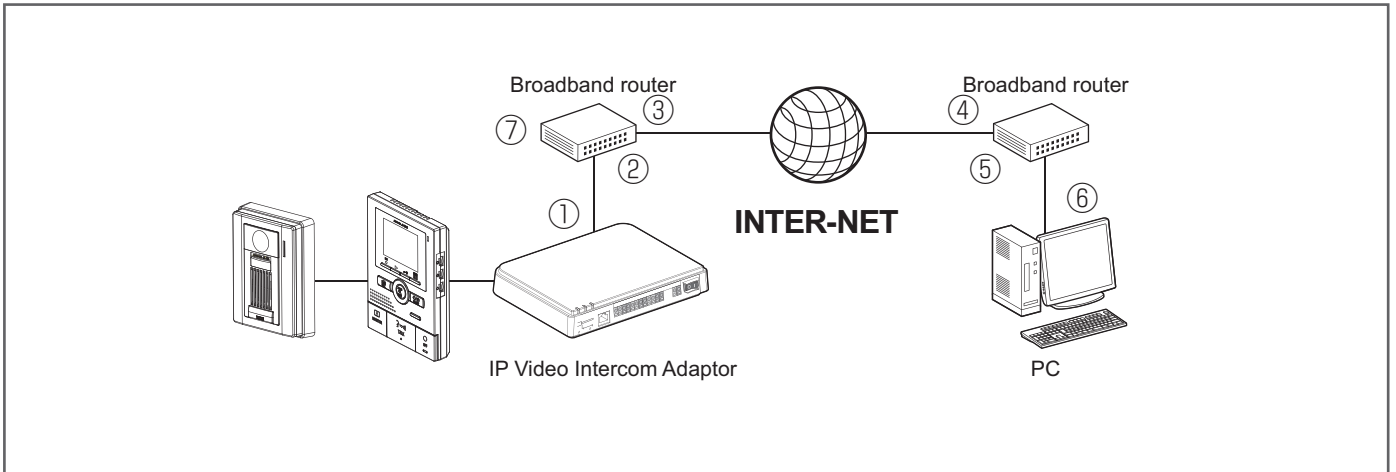

① Local IP Address and Subnet Mask of the IP Video Intercom Adaptor

② Local IP Address of the broadband router

⑦ Enter if Email will be sent

OFF except for the broadband router that is confirmed to support UPnP

③ Global IP Address of the broadband router on the IP Video Intercom Adaptor side

Change if necessary.

③ Global IP Address of the broadband router on the IP Video Intercom Adaptor side

Port numbers of the IP Video Intercom Adaptor

Option  
Entering the ID and Password here will make it unnecessary to enter them at login.

OFF except for the broadband router that is confirmed to support UPnP

⑥ IP Address that was allocated to the PC

④ Global IP Address of the broadband router on the PC side

Change if necessary. Set for each port type.

① Local IP Address and Subnet Mask of the IP Video Intercom Adaptor

② Local IP Address of the broadband router

⑦ Enter if Email will be sent

OFF except for the broadband router that is confirmed to support UPnP

③ Global IP Address of the broadband router on the IP Video Intercom Adaptor side

Change if necessary.

③ Global IP Address of the broadband router on the IP Video Intercom Adaptor side

Port numbers of the IP Video Intercom Adaptor

Option  
Entering the ID and Password here will make it unnecessary to enter them at login.

OFF except for the broadband router that is confirmed to support UPnP

⑥ IP Address that was allocated to the PC

④ Global IP Address of the broadband router on the PC side

Change if necessary. Set for each port type.

\*: For the broadband router setting information, see the Operation Manual supplied with the broadband router.

\*: The values shown above are the factory default settings.

## Regulations

### FCC

This device complies with part 15 of the FCC Rules. Operation is subject to the following two conditions: (1) This device may not cause harmful interference, and (2) this device must accept any interference received, including interference that may cause undesired operation.

NOTE: This equipment has been tested and found to comply with the limits for a Class B digital device, pursuant to part 15 of the FCC Rules. These limits are designed to provide reasonable protection against harmful interference in a residential installation. This equipment generates, uses and can radiate radio frequency energy and, if not installed and used in accordance with the instructions, may cause harmful interference to radio communications. However, there is no guarantee that interference will not occur in a particular installation. If this equipment does cause harmful interference to radio or television reception, which can be determined by turning the equipment off and on, the user is encouraged to try to correct the interference by one or more of the following measures:

- Reorient or relocate the receiving antenna.
- Increase the separation between the equipment and receiver.
- Connect the equipment into an outlet on a circuit different from that to which the receiver is connected.
- Consult the dealer or an experienced radio/TV technician for help.

INDUSTRY CANADA  
CAN ICES-3 (B)/NMB-3(B)

### WEEE

The object area of  is the EU.

## Warranty

Aiphone warrants its products to be free from defects of material and workmanship under normal use and service for a period of two years after delivery to the ultimate user and will repair free of charge or replace at no charge, should it become defective upon which examination shall disclose to be defective and under warranty. Aiphone reserves unto itself the sole right to make the final decision whether there is a defect in materials and/or workmanship, and whether or not the product is within the warranty. This warranty shall not apply to any Aiphone product which has been subject to misuse, neglect, accident, power surge, or to use in violation of instructions furnished, nor extended to units which have been repaired or altered outside of the factory. This warranty does not cover batteries or damage caused by batteries used in connection with the unit. This warranty covers bench repairs only, and any repairs must be made at the shop or place designated in writing by Aiphone. This warranty is limited to the standard specifications listed in the operation manual. This warranty does not cover any supplementary function of a third party product that is added by users or suppliers. Please note that any damage or other issues caused by failure of function or interconnection with Aiphone products is also not covered by this warranty. Aiphone will not be responsible for any costs incurred involving on site service calls. Aiphone will not provide compensation for any loss or damage incurred by the breakdown or malfunction of its products during use, or for any consequent inconvenience or losses that may result.

 **AIPHONE**®  
*Providing Peace of Mind*  
<http://www.aiphone.net/>